

Panasonic®

Operating Instructions

SIP Phone

Model No. **KX-HDV130**



Thank you for purchasing this Panasonic product.

Please read this manual carefully before using this product and save this manual for future use.

Note

- In this manual, the suffix of each model number is omitted unless necessary.
- The illustrations such as some keys may differ from the appearance of the actual product.
- Certain products and features described in this document may not be available in your country or area. Contact your phone system dealer/service provider.
- The contents and design of the software are subject to change without notice.

Document Version: 2016-03

Introduction

Outline

This manual describes information about the installation and operation of KX-HDV130.

Related Documentation

- **Quick Start Guide**

Describes basic information about the installation and safety precautions to prevent personal injury and/or damage to property.

- **Administrator Guide**

Describes detailed information about the configuration and management of this unit.

Manuals and supporting information are provided on the Panasonic Web site at:

<http://panasonic.net/pcc/support/sipphone>

For Future Reference

Record the information in the space below for future reference.

Note

- The serial number and MAC address of this product may be found on the label affixed to the bottom of the unit. You should note the serial number and MAC address of this unit in the space provided and retain this manual as a permanent record of your purchase to aid in identification in the event of theft.

MODEL NO.	_____
SERIAL NO.	_____
MAC ADDRESS	_____
DATE OF PURCHASE	_____
NAME OF DEALER	_____
DEALER'S ADDRESS	_____ _____ _____
DEALER'S TEL. NO.	_____

Important Information
 Important Information4
 For Users in European Countries5
 For Users in the United Kingdom5
 For Users in Australia5
 For Users in Australia and the United Kingdom6
 For Users in New Zealand6
 For Users in the United States6
 For Users in Canada8
 For Best Performance9

Before Operating the Telephones
 Accessory Information10
 Location of Controls11
 The Display and Icons17
 Adjusting the Volume23
 Incoming/Outgoing Call Log23
 Setting the Password24
 Selecting the Display Language24
 Entering Characters25
 Basic Operation26

Making Calls
 Making Calls27
 Basic Calling27
 Easy Dialing27
 Making a Multicast Voice Paging call29

Receiving Calls
 Receiving Calls30
 Answering Calls30
 Hands-free Mode30

During a Conversation
 During a Conversation32

Before Leaving Your Desk
 Call Forwarding/Do Not Disturb35
 Listening to Voice Mail Messages35

Using the Phonebook
 Using the Phonebook36
 Using the Local Phonebook37
 Using the Remote Phonebook43
 ECO Mode43

Customizing the Telephone
 Customizing the Telephone44

Installation and Setup
 Installation and Setup50
 Updating the software55

Appendix
 Appendix56

Revision History72

Important Information

Data Security

- To avoid unauthorized access to this product:
 - Keep the password secret.
 - Change the default password.
 - Set a password that is random and cannot be easily guessed.
 - Change the password regularly.
- This product can store your private/confidential information. To protect your privacy/confidentiality, we recommend that you erase the information such as the phonebook or call log from the memory before you dispose of, transfer or return the product, or have the product repaired.
- It is recommended that you lock the phonebook to prevent stored information from being leaked.

Information for Users on Collection and Disposal of Old Equipment and used Batteries

Information for Users on Collection and Disposal of Old Equipment and used Batteries



These symbols on the products, packaging, and/or accompanying documents mean that used electrical and electronic products and batteries should not be mixed with general household waste.

For proper treatment, recovery and recycling of old products and used batteries, please take them to applicable collection points, in accordance with your national legislation and the Directives 2002/96/EC and 2006/66/EC.

By disposing of these products and batteries correctly, you will help to save valuable resources and prevent any potential negative effects on human health and the environment which could otherwise arise from inappropriate waste handling.

For more information about collection and recycling of old products and batteries, please contact your local municipality, your waste disposal service or the point of sale where you purchased the items.

Penalties may be applicable for incorrect disposal of this waste, in accordance with national legislation.

For business users in the European Union

If you wish to discard electrical and electronic equipment, please contact your dealer or supplier for further information.



Information on Disposal in other Countries outside the European Union

These symbols are only valid in the European Union. If you wish to discard these items, please contact your local authorities or dealer and ask for the correct method of disposal.



Note for the battery symbol (bottom two symbol examples):

This symbol might be used in combination with a chemical symbol. In this case it complies with the requirement set by the Directive for the chemical involved.

For Users in European Countries

The following declaration is applicable to KX-HDV130NE/KX-HDV130X only



For information of Compliance with EU relevant Regulatory Directives,

Contact to Authorized Representative:

Panasonic Testing Center

Panasonic Marketing Europe GmbH

Winsbergring 15, 22525 Hamburg, Germany

Ecodesign information

Ecodesign information under EU Regulation (EC) No.1275/2008 amended by (EU) Regulation No. 801/2013.

=====

Please visit here: www.ptc.panasonic.eu

click [Downloads]

→ Energy related products information (Public)

=====

Power consumption in networked standby and guidance are mentioned in the web site above.

For Users in the United Kingdom

- This unit is designed to be installed under controlled conditions of ambient temperature and a relative humidity.
- Avoid installing the unit in damp or humid environments, such as bathrooms or swimming pools.
- 999 and 112 can be dialed on the product after accessing the outside line for the purpose of making outgoing calls to the BT emergency (999) and (112) services.
The method for accessing an outside line differs depending on the SIP server. For details, confirm the features of the SIP server.

For Users in Australia

WARNING

- Please ensure that a separate telephone, not dependent on local power, is available for emergency use.
- This equipment will be inoperable when mains power fails.
- No "000" or other calls can be made from this device during a mains power failure.

For Users in Australia and the United Kingdom

- This unit is capable of being used in conjunction with hearing aids fitted with inductive coil pick-ups. The handset should be held as for normal conversation. For operation, the hearing aid should be set to its "T" position or as directed in the operating instructions for the hearing aid.
- This unit is designed to aid the visually handicapped to locate dial keys and buttons.



For Users in New Zealand

- This equipment shall not be set to make automatic calls to the Telecom '111' Emergency Service.

PTC General Warning

- The grant of a Telepermit for any item of terminal equipment indicates only that Telecom has accepted that the item complies with minimum conditions for connection to its network. It indicates no endorsement of the product by Telecom, nor does it provide any sort of warranty. Above all, it provides no assurance that any item will work correctly in all respects with another item of Telepermitted equipment of a different make or model, nor does it imply that any product is compatible with all of Telecom's network services.

The Use of IP Networks through the PSTN

- Internet Protocol (IP) by its nature introduces delay into speech signals as each data packet is formulated and addressed. Telecom Access Standards recommends that suppliers, designers and installers using this technology for calls to or from the PSTN refer to ITU E Model requirements in the design of their networks. The overall aim is to minimize delay, distortion and other transmission impairments, particularly for those calls involving cellular and international networks, which already suffer extensive delay.

Echo cancellation

- Echo cancelers are not normally required in the Telecom PSTN because geographic delays are acceptable where CPE return loss is maintained within Telepermit limits. However, those private networks making use of Voice over IP technology are required to provide echo cancellation for all voice calls. The combined effect of audio/VoIP conversion delay and IP routing delay can cause the echo cancellation time of ≥ 64 ms to be required.

Important Notice

- Under power failure conditions this appliance may not operate. Please ensure that a separate telephone, not dependent on local power, is available for emergency use.
- No "111" or other calls can be made from this device during a mains power failure.

For Users in the United States

Note

- This equipment has been tested and found to comply with the limits for a Class B digital device, pursuant to Part 15 of the FCC Rules. These limits are designed to provide reasonable protection against harmful interference in a residential installation. This equipment generates, uses, and can radiate radio frequency energy and, if not installed and used in accordance with the instructions, may cause harmful interference to radio communications. However, there is no guarantee that interference will not occur in a particular installation. If this equipment does cause harmful interference to radio or

television reception, which can be determined by turning the equipment off and on, the user is encouraged to try to correct the interference by one or more of the following measures:

- Reorient or relocate the receiving antenna.
- Increase the separation between the equipment and receiver.
- Connect the equipment to an outlet on a circuit different from that to which the receiver is connected.
- Consult the dealer or an experienced radio/TV technician for help.

This device complies with Part 15 of the FCC Rules. Operation is subject to the following two conditions:

(1) this device may not cause harmful interference, and (2) this device must accept any interference received, including interference that may cause undesired operation.

WHEN PROGRAMMING EMERGENCY NUMBERS AND/OR MAKING TEST CALLS TO EMERGENCY NUMBERS:

1. Remain on the line and briefly explain to the dispatcher the reason for the call before hanging up.
2. Perform such activities during off-peak hours, such as early morning or late evening.

CAUTION

Any changes or modifications not expressly approved by the party responsible for compliance could void the user's authority to operate this product.

Hearing Aid Compatibility

This telephone provides magnetic coupling for hearing aids as defined by the FCC in 47 CFR Section 68.316. Use only handsets or other acoustic devices with this equipment that are compliant with the hearing aid compatibility requirements of FCC Part 68.

When you hold the phone to your ear, noise might be heard in your Hearing Aid. Some Hearing Aids are not adequately shielded from external RF (radio frequency) energy. If noise occurs, use an optional headset accessory or the speakerphone option (if applicable) when using this phone. Consult your audiologist or Hearing Aid manufacturer about the availability of Hearing Aids which provide adequate shielding to RF energy commonly emitted by digital devices.

Compliance with TIA-1083 standard:



Telephone handsets identified with this logo have reduced noise and interference when used with T-Coil equipped hearing aids and cochlear implants.

Responsible Party

Panasonic Corporation of North America
Two Riverfront Plaza, Newark, NJ 07102-5490

Technical Support

Panasonic Corporation of North America
Two Riverfront Plaza, Newark, NJ 07102-5490
Telephone: 1-800-211-PANA (7262)

For Users in Canada

Industry Canada Notices and Other Information

This product meets the applicable Industry Canada technical specifications.

Note

- This Class B digital apparatus complies with Canadian ICES-003.

CAUTION

Any changes or modifications not expressly approved by the party responsible for compliance could void the user's authority to operate this product.

Compliance with TIA-1083 standard:



Telephone handsets identified with this logo have reduced noise and interference when used with T-Coil equipped hearing aids and cochlear implants.

For Best Performance

Environment

- Keep the product away from heating appliances and devices that generate electrical noise, such as fluorescent lamps, motors and televisions. These noise sources can interfere with the performance of the product.
- Do not place the product in rooms where the temperature is less than 0 °C (32 °F) or greater than 40 °C (104 °F).
- Allow 10 cm (3–15/16 in) clearance around the product for proper ventilation.
- Avoid environments with excessive smoke, dust, moisture, mechanical vibration, shock, or direct sunlight.
- The apparatus is designed to be installed and operated under controlled conditions of ambient temperature and a relative humidity.

Routine Care



- Unplug the AC adaptor from the AC outlet and disconnect the Ethernet cable before cleaning.
- Wipe the product with a soft cloth.
- Do not clean the product with abrasive powder or with chemical agents such as benzine or thinner.
- Do not use liquid cleaners or aerosol cleaners.

Placement

- Do not place heavy objects on top of the product.
- Care should be taken so that objects do not fall onto, and liquids are not spilled into, the product.

Accessory Information

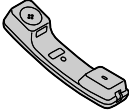
Included Accessories

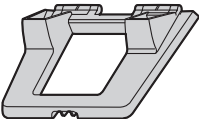
Handset: 1 	Handset Cord: 1 	Stand: 1 
---	--	---

Optional Accessories

Item	Model	AC Adaptor Model No.*2
AC Adaptor*1	KX-HDV130/ KX-HDV130C	KX-A423 (PQLV219)
	KX-HDV130NE/ KX-HDV130RU	KX-A423CE (PQLV219CE)
	KX-HDV130X	KX-A423AG (PQLV219AG)/KX-A423AL (PQLV219AL)/ KX-A423BR (PQLV219BR)/KX-A423CE (PQLV219CE)/ KX-A423E (PQLV219E)/KX-A423X (PQLV219)
	KX-HDV130SX	KX-A423SX (PQLV219SX)

*1 This unit complies with the IEEE 802.3af Power-over-Ethernet (PoE) standard. If PoE is available on your network, this unit can receive the necessary power from the network through the Ethernet cable. In this case, no AC adaptor is needed. However, if PoE is not available, you will need to connect an AC adaptor to the unit.

*2 To order an optional AC adaptor, please order using the "KX-A423xx" model number. For details about which AC adaptor model number you should order, consult your dealer.

Item	Model No.
Wall mount kit	KX-HDV130/KX-HDV130C: KX-A440
	KX-HDV130NE/KX-HDV130RU/KX-HDV130X: KX-A440X
	KX-HDV130SX: KX-A440SX

Note

For users in the United States only

To order accessories, call toll-free **1-800-332-5368**.

Location of Controls

KX-HDV130

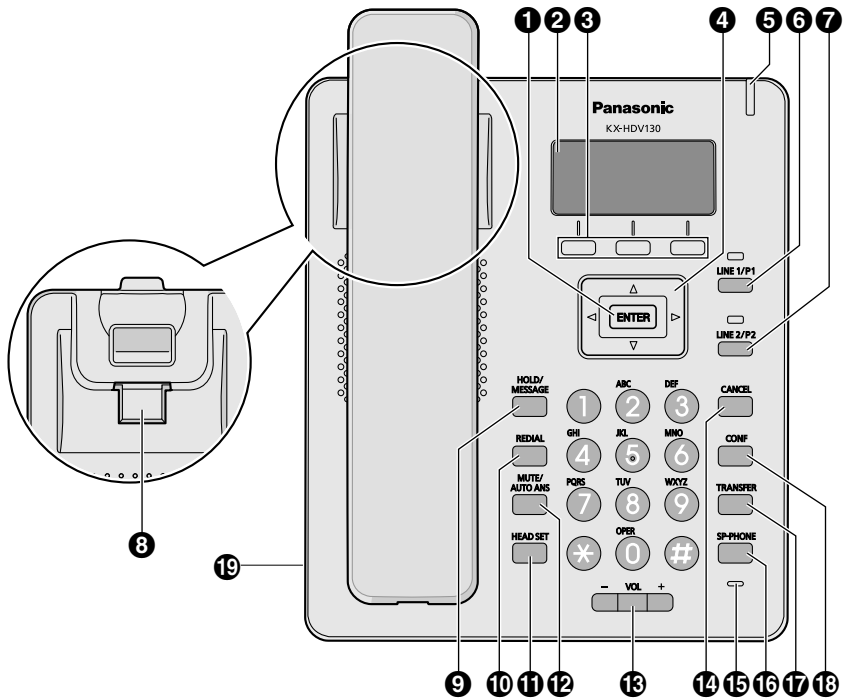

Before Operating the Telephones

KX-HDV130C

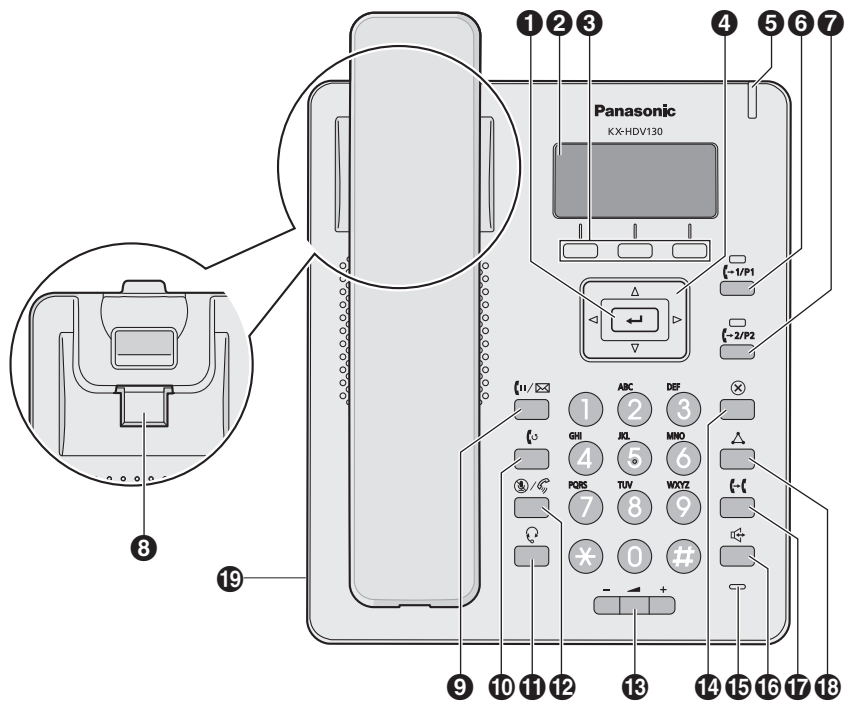

KX-HDV130RU

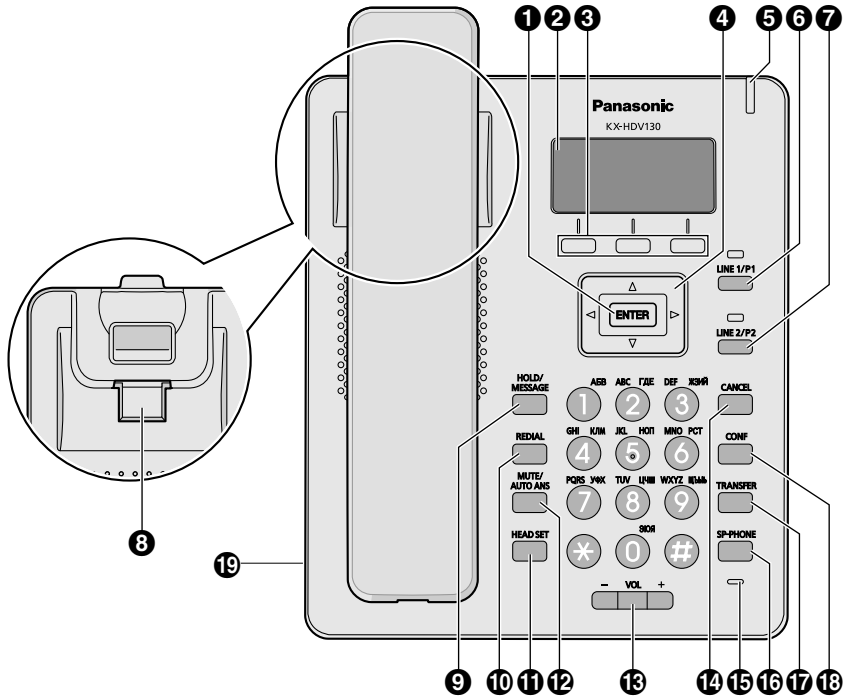

Before Operating the Telephones

KX-HDV130X/KX-HDV130SX

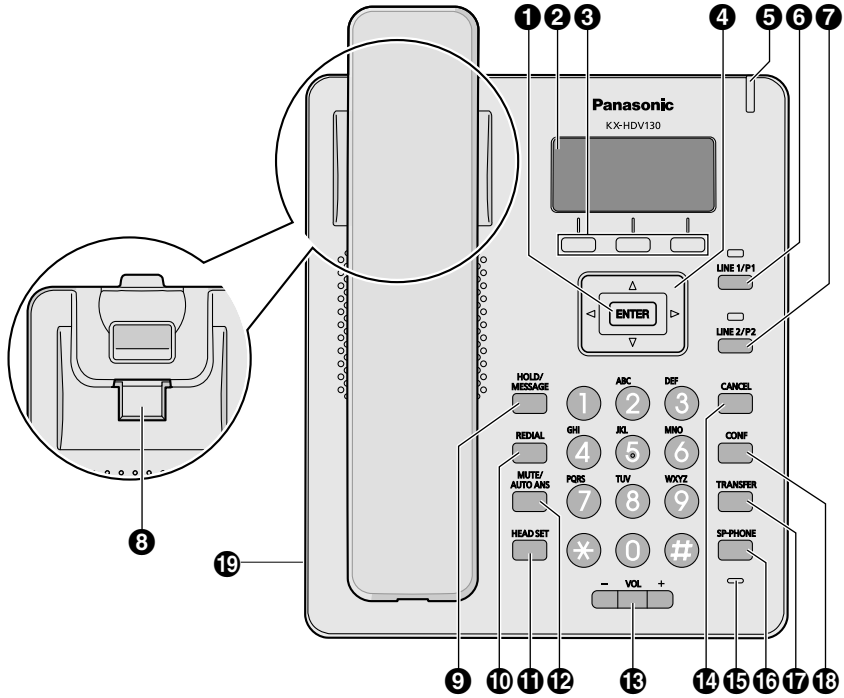

KX-HDV130NE

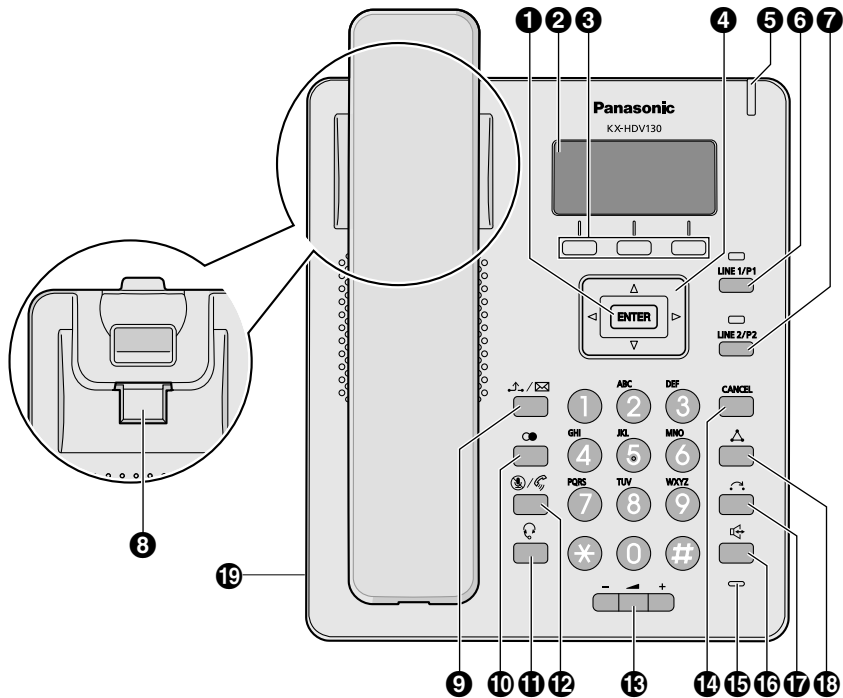

1 ←/ENTER

Used to confirm the selected item.

2 LCD (Liquid Crystal Display)

For details about the LCD, see “Display”, Page 17.

3 Soft Keys

A/B/C (located from left to right) are used to select the item displayed on the bottom line of the display. For details about the soft keys, see “Soft Keys”, Page 18.

4 Navigator Key

The Navigator Key includes four direction keys. The direction keys are used to move the cursor to select an item. If in standby mode, pressing the keys perform the following functions:

LEFT (◀) → Used to display the Incoming call log.*1

RIGHT (▶) → Used to open the phonebook.*1

*1 When the BroadCloud (Presence) feature is enabled, the phone will operate as follows. Contact your administrator for further information.

LEFT: Used to display Presence.

RIGHT: Used to display Favorites.

5 Ringer/Message Waiting/Missed Call Indicator

The lamp flashes when you are receiving a call, or when you have an unread message or missed call notification.

6 ←/P1/LINE/Program Key 1

Used to perform the assigned function. When this key is assigned as a Line key, it can be used to confirm the status or seize line 1. For details about changing the program keys, see “Changing the Program Keys”, Page 45.

For details about the line keys, see “LINE Keys”, Page 21.

Before Operating the Telephones

7 /LINE/Program Key 2

Used to perform the assigned function. When this key is assigned as a Line key, it can be used to confirm the status or seize line 2. For details about changing the program keys, see “Changing the Program Keys”, Page 45.

For details about the line keys, see “LINE Keys”, Page 21.

8 **Handset Hook**

Keeps the handset stable when the unit is mounted on a wall. For details, see “Hooking the Handset”, Page 54.

9 /HOLD/MESSAGE

During talking, used to place a call on Hold. In standby mode, used to retrieve a call on hold if there is one, or used to access your voice mailbox if no call is on hold.

10 /REDIAL

Used to redial the last dialed number.

11 /HEADSET

Used for performing headset operations.

12 /MUTE/AUTO ANS

Used to receive an incoming call in hands-free mode or mute the microphone/handset during a conversation.

13 /VOL

Used to adjust the ringer/receiver volume.

14 /CANCEL

Used to cancel the selected item.

15 **Microphone**

Used for hands-free conversation.

16 /SP-PHONE

Used for performing hands-free operations.

17 /TRANSFER

Used to transfer a call to another party.

18 /CONF

Used to establish a multiple-party conversation.

19 **Headset Jack**

Optional headsets can be used with this unit. (Not all operations with the headsets can be guaranteed.) For up-to-date information about headsets that have been tested with this unit, refer to the following web site:

<http://panasonic.net/pcc/support/sipphone>

The Display and Icons

Display

[Example]

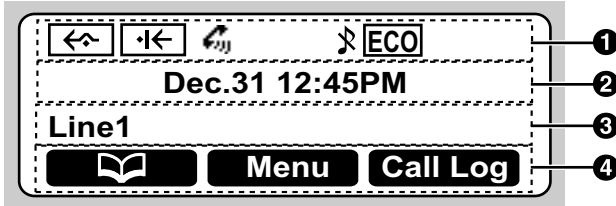

1 Pictographs

Suffix		Meaning
(none)/C	NE/RU/SX/X	
Fwd		Call Forwarding
DND		Do Not Disturb
Auto Ans.		Auto Answer
		Ringer Off
	ECO	ECO Mode
		Standby display page switcher

2 Date and Time Display

3 Missed Call, New Message, or Name/Number Display

4 Soft Keys

For more information, see “Soft Keys”, Page 18.

Note

- In standby mode, the line name is displayed. In all other modes, if only one line is configured on the telephone, the line name is not displayed.
- Example images of the display in this manual are samples only, and the actual screen on your phone may vary in color and/or appearance.







Before Operating the Telephones

Soft Keys





Icons and information shown on the display will vary depending on the context. To select an item shown on the display, press the corresponding soft key.

Icons may differ from the appearance of the actual product.





Soft Key A (Left key)

Suffix		Meaning
(none)/C	NE/RU/ SX/X	
		Opens the phonebook. Pressing this key for more than 2 seconds locks the phonebook.
		Returns to the previous display.
		Displayed when in Phonebook Lock. Pressing this key and then entering the password (default: not registered), unlocks the phonebook temporarily. Pressing for more than 2 seconds, then entering the password (default: not registered), unlocks the phonebook. If no password has been set, you cannot lock the phonebook. For details about setting the password, see "Setting the Password", Page 24.
		Answers a call.
		Establishes a multiple-party conversation (Conference).

Soft Key B (Middle key)

Suffix		Meaning
(none)/C	NE/RU/ SX/X	
		Opens the main menu.
		Confirms the entry.
		Makes a call.
		Turns the ringer off.
		Stores a new item in the phonebook.

Soft Key C (Right key)

Suffix		Meaning
(none)/C	NE/RU/ SX/X	
		Opens the Outgoing Call Log.
		Opens the Incoming Call Log.
		Performs an unscreened (blind) transfer.

ABC	Displayed when in Latin character entry mode.
0 - 9	Displayed when in Numeric character entry mode.
+ÂÂ ÃÃÃ	Displayed when in Special character (Extended 1) entry mode.
Reject	Used to reject an incoming call.
Next	Advances to the next display.
Clear	Clears digits or characters.
Search	Searches for an item in the phonebook alphabetically.
AM/PM	Used to select AM or PM when setting the time.
Cancel	Used to cancel the setting.
Delete	Used to delete the setting.
Save	Used to save a setting.
Sšš	Displayed when in Special character (Extended 2) entry mode.
Fwd/DND *1 ↔/K *1	Used to set Call Forwarding and Do Not Disturb.
ABΓ	Displayed when in Greek character entry mode.
АБВ	Displayed when in Cyrillic character entry mode.
HOT0 — HOT9 *1	Dials the number assigned to the Hot Key.
Page *1*2	Used to make a Multicast Voice Paging call.
Park *1*2	Used to retrieve a parked call (Call Parking).
Call Log	Opens the call log.
Recall *1	Disconnects the current call and allows you to make another call without hanging up.
Pause *1*2	Inserts a dialing pause.

*1 This soft key can be configured to appear as Soft Key A, B, or C.

*2 This soft key is displayed only when configured on the telephone.

Editing Soft Keys

Reverting to the default settings

[In standby mode]

1. **Menu**
2. [▲]/[▼]: "Basic Settings" → **OK**
3. [▲]/[▼]: "Key Option" → **OK**
4. [▲]/[▼]: "Soft Key Edit" → **OK**
5. [▲]/[▼]: Select a desired soft key. → **OK**

Before Operating the Telephones

6. [▲]/[▼]: "Standby"/"Talking" → **OK**

7. [▲]/[▼]: "Default" → **OK**

Assigning Function Keys

[In standby mode]

1. **Menu**

2. [▲]/[▼]: "Basic Settings" → **OK**

3. [▲]/[▼]: "Key Option" → **OK**

4. [▲]/[▼]: "Soft Key Edit" → **OK**

5. [▲]/[▼]: Select a desired soft key. → **OK**

6. [▲]/[▼]: "Standby"/"Talking" → **OK**

7. [▲]/[▼]: "Function Key" → **OK**

8. [▲]/[▼]: Select the desired item. → **OK**

Assigning Hot Key Dial keys

[In standby mode]

1. **Menu**

2. [▲]/[▼]: "Basic Settings" → **OK**

3. [▲]/[▼]: "Key Option" → **OK**

4. [▲]/[▼]: "Soft Key Edit" → **OK**

5. [▲]/[▼]: Select a desired soft key. → **OK**

6. [▲]/[▼]: "Standby"/"Talking" → **OK**

7. [▲]/[▼]: "Hot Key Dial" → **OK**

8. [▲]/[▼]: Select the desired item. → **OK**

LINE Keys

If a line is assigned to a program key, the program key works as a line key. In this case, the line key can be used to seize a line in order to make or receive a call. The color of each key's LED indicates the status of the line. For details about changing the setting of program keys, see "Changing the Program Keys", Page 45.

Status Indication

Status		Meaning
Color	Light pattern	
Blue	On	In Use <ul style="list-style-type: none">● You are on a call.
	Slow Flashing	"Line On Hold" <ul style="list-style-type: none">● A call is on hold.
	Quick Flashing	"Incoming Call/Recall" <ul style="list-style-type: none">● A call (including Hold Recall) is being received. Name or number of caller● A call to a shared line is being received.
Red	On	In Use <ul style="list-style-type: none">● A shared line is in use or a call is on private hold at another unit.
	Slow Flashing	"Line On Hold" <ul style="list-style-type: none">● A shared line is on hold at another unit.
Off	—	Free <ul style="list-style-type: none">● The line is idle.

Before Operating the Telephones

Main Menu

Press **Menu** to display the following main menu.

Call Center*1

Used to access the Call Center feature.

Presence*1

Used to access the Presence feature.

FWD/DND

Sets the Call Forwarding or Do Not Disturb features.

See “Call Forwarding/Do Not Disturb”, Page 35.

Paging*1

Makes a Multicast Voice Paging call.

See “Making a Multicast Voice Paging call”, Page 29.

New Phonebook

Adds a new entry into the local phonebook.

See “Storing an Item in the Local Phonebook”, Page 37.

Incoming Log

Used to display the incoming call log.

See “Incoming/Outgoing Call Log”, Page 23.

Outgoing Log

Used to display the outgoing call log.

See “Incoming/Outgoing Call Log”, Page 23.

Phonebook

Used to access the local or remote phonebook.

See “Using the Phonebook”, Page 36.

ECO Mode

Sets the ECO mode feature.

See “ECO Mode”, Page 43.

Basic Settings

Used to access the basic settings menu.

See “Changing the Basic Settings”, Page 47.

System Settings

Used to access the system settings menu.

See “Changing the System Settings”, Page 48.

Application*1

Used to access the Application feature.

*1 This item is displayed only when the feature is enabled. Contact your administrator for further information.

Adjusting the Volume

Adjusting the Receiver/Speaker/Headset Volume

1. [-]/[+] volume key: Adjust the volume during a conversation.

Adjusting the Ringer Volume or Turning the Ringer Off

[In standby mode]

1. [-]/[+] volume key: Adjust the ringer volume.

Note

- For details about setting the ringer pattern, see "Incoming Option", Page 59.

Adjusting the Ringer Volume or Turning the Ringer Off while Ringing

While receiving a call, do the following to adjust the ringer volume or turn the ringer off:

Note

- If you attach a headset while receiving an incoming call, ringing will be heard from the speaker.

To adjust the ringer volume

1. [-]/[+] volume key: Adjust the ringer volume.*1
2. **Back**: Exit.

*1 The adjusted volume level will also be used for subsequent calls.

To turn the ringer off

1. 

Incoming/Outgoing Call Log

Displaying the Incoming Call Log

[In standby mode]

1. [◀]
2. [▲]/[▼]: "Incoming Log" → **OK**

Note

- If "Missed Calls" is displayed on the LCD in standby mode, select "Missed Call" at step 2.

Displaying the Outgoing Call Log

[In standby mode]

1. **Call Log**
2. [▲]/[▼]: "Outgoing Log" → **OK**

Note

- If "Missed Calls" is displayed on the LCD in standby mode, select "Missed Call" at step 2.

Making a call using the Incoming/Outgoing Call Log

See "Using the Incoming/Outgoing Call Log", Page 28.

Storing an item using the Incoming/Outgoing Call Log

See "Storing an Item Using the Incoming or Outgoing Call Log", Page 38.

Before Operating the Telephones

Deleting Items in the Incoming Call Log

[When the Incoming Call Log is displayed]

1. [▲]/[▼]: Select the desired item. → **Menu**
 2. [▲]/[▼]: "Delete"*1 → **OK**
 3. [▲]/[▼]: "Yes" → **OK**
- *1 You can select "Delete All" instead to delete all items.
-

Deleting Items in the Outgoing Call Log

[When the Outgoing Call Log is displayed]

1. [▲]/[▼]: Select the desired item. → **Menu**
 2. [▲]/[▼]: "Delete"*1 → **OK**
 3. [▲]/[▼]: "Yes" → **OK**
- *1 You can select "Delete All" instead to delete all items.
-

Setting the Password

The telephone password is not set by default. You must register a password (4 digits) before use. You cannot use the following features without setting a password:

- Phonebook lock (See "Locking the Local Phonebook", Page 41).

Note

- To avoid unauthorized access to this product:
 - Set a password that is random and cannot be easily guessed.
 - Change the password regularly.
 - Make a note of the password so that you will not forget it.
-

To set

[In standby mode]

1. **Menu**
 2. [▲]/[▼]: "Basic Settings" → **OK**
 3. [▲]/[▼]: "Other Option" → **OK**
 4. [▲]/[▼]: "Change Password" → **OK**
 5. Enter a new password (4 digits [0–9]).
 6. Verify the password by entering it again as in step 5.
-

Selecting the Display Language

You can select the language displayed on your LCD.

[In standby mode]

1. **Menu**
 2. [▲]/[▼]: "Basic Settings" → **OK**
 3. [▲]/[▼]: "Display Option" → **OK**
 4. [▲]/[▼]: "Language" → **OK**
-

5. [▲]/[▼]: Select a language. → **OK**

- For a list of the languages that can be selected, see “Display Option”, Page 61.

Entering Characters

You can enter characters and digits using the dialing keys.

You can select one of the character modes by pressing the **Right Soft Key** while entering a name. The function icon above the soft key displays the current character mode.

For available characters, see “Character Mode Table”, Page 56.

To change the character mode while editing a name in the Phonebook, press the **Right Soft Key**.

Model No.	Character Mode Transition
KX-HDV130, KX-HDV130C	<p>ABC (Latin) ↓ 0-9 (Numeric) ↓ +RrR (Extended 1)</p>
KX-HDV130NE, KX-HDV130X, KX-HDV130SX	<p>ABC (Latin) ↓ 0-9 (Numeric) ↓ ABΓ (Greek) ↓ RrR (Extended 1) ↓ SSŠ (Extended 2)</p>
KX-HDV130RU	<p>ABB (Cyrillic) ↓ 0-9 (Numeric) ↓ ABC (Latin) ↓ RrR (Extended 1) ↓ SSŠ (Extended 2)</p>

Example: To enter "Anne" in Latin Mode.

[2] → [▶] → [x] → [6] → [6] → [▶] → [6] → [6] → [▶] → [3] → [3]

- To switch between uppercase and lowercase, press [x].
- To enter a character located on the same dialing key as the previous character, move the cursor by pressing the Navigator Key ▶, then enter the desired character.
- If you enter a different character by mistake, press the Navigator Key [◀] or [▶] to highlight the character, press **Clear** to delete it, then enter the correct character.
- To clear an entire line, press **Clear** for more than 1 second.
- To move the cursor, press the Navigator Key [◀], [▶], [▲] or [▼].

Basic Operation

Going off- and on-hook

There are several ways to go off-hook and on-hook:

- Using the corded handset
- Using the \mathbb{P} /[SP-PHONE], \mathbb{H} /[HEADSET], \mathbb{X} /[CANCEL] key
- Using the soft key

Going off-hook

In this manual, when you see the phrase "off-hook", you can do any of the following:

- Lift the corded handset off its cradle.
- Press \mathbb{P} /[SP-PHONE] while the corded handset is on its cradle. This enables hands-free mode.
- Press \mathbb{H} /[HEADSET] when using a headset.
- Press the corresponding \mathbb{L} /[LINE] key to select a line.*1

*1 When a program key is assigned as a Line key, this feature is available.

Going on-hook

In this manual, when you see the phrase "on-hook", you can do any of the following:

- Replace the corded handset on its cradle.
- Press \mathbb{P} /[SP-PHONE], \mathbb{X} /[CANCEL] when you are in hands-free mode.
- Press \mathbb{H} /[HEADSET], \mathbb{X} /[CANCEL] when using a headset.
- Press \mathbb{X} /[CANCEL].

Making Calls

- You can confirm that the number was dialed correctly before calling (Predialing) by entering the number, then going off-hook.
- To clear an entire number while predialing, press **Clear** for more than 1 second.
- If an outside call is received from a phone number stored in the Phonebook, the number and name of the caller will be displayed in the call log.
- To cancel dialing, press **⊗**/[CANCEL].
- To insert a 3 second pause between phone numbers, press **Pause** *1.
It is useful when you want to operate voice mail service without listening to pre-recorded announcement, for example. Repeat as needed to create longer pauses.

*1 This soft key is displayed only when configured on the telephone. Contact your administrator for further information.

Basic Calling

Calling by Dialing

1. In standby mode, go off-hook.
2. Dial the outside party's number.
3. **Call**
4. Go on-hook to end the call.

Note

To dial a new number without going on-hook, follow the procedure below.

1. **Menu**
2. **[▲]/[▼]**: "Flash/Recall"
3. **OK**

Predialing

In standby mode, you can start dialing while still on-hook. After dialing the number, go off-hook to begin the call.

Easy Dialing

Making a call using the redial list

The last phone number dialed is stored in the redial list (32 digits max.).

[In standby mode]

1. **☎**/[**☎**]/[REDIAL]
2. Go off-hook.

Hot Key Dialing

You can assign a phone number to each number key and then access the desired phone number by simply pressing and holding the assigned number key.

Making Calls

1. Press and hold the dialing key (0–9) assigned as a Hot Key for more than 1 second.
2. Go off-hook.

Note

- While the Hot Key's information is displayed, you can press [▲] or [▼] to select another Hot Key number.
- If Hot Key dialing is set to "Auto", a Hot Key number can also be dialed by pressing and holding the assigned dialing key for a specified number of seconds. For details, see "Selecting the Type of Hot Key Dialing", Page 45.
- For details about assigning Hot Keys, see "Assigning Hot Keys From Phonebook", Page 44.

Using the Hot Line

If your administrator has configured this function, you can make a call to a registered phone number automatically. Contact your administrator for further information.

[In standby mode]

1. Go off-hook.

Using the Incoming/Outgoing Call Log

Using the Incoming Call Log

[In standby mode]

1. [◀]
2. [▲]/[▼]: "Incoming Log" → **OK**
3. [▲]/[▼]: Select an incoming call log.
4. Go off-hook.
5. Go on-hook to end the call.

Note

- If "Missed Calls" is displayed on the LCD in standby mode, you can select "Missed Call" at step 2 to select a number to call.

Using the Outgoing Call Log

[In standby mode]

1. **Call Log**
2. [▲]/[▼]: "Outgoing Log" → **OK**
3. [▲]/[▼]: Select an outgoing call log.
4. Go off-hook.
5. Go on-hook to end the call.

Note

- If "Missed Calls" is displayed on the LCD in standby mode, you can select "Missed Call" at step 2 to select a number to call.

Using the Phonebook

Using the Local Phonebook

[In standby mode]

1. 
2. [▲]/[▼]: "Phonebook" → **OK***1

3. Enter the name or the first character(s) of the desired name. → **OK**
 4. [▲]/[▼]: Select the desired item. → ↵/[ENTER]^{*2}
 5. [▲]/[▼]: Select the desired phone number.
 6. Go off-hook.
 7. Go on-hook to end the call.
- *1 If only Local Phonebook is permitted, this step is skipped.
 *2 If you push and hold [▲]/[▼], the next/previous items will be displayed automatically.

Note

- If the Local Phonebook is not permitted, this feature cannot be used. Contact your administrator for further information.
- For details about making a call using the Phonebook, see "Searching for an Item in the Local Phonebook", Page 40.

Using the Remote Phonebook

[In standby mode]

1. 
 2. [▲]/[▼]: "Remote Phonebook" → **OK**^{*1}
 3. Enter the name or the first character(s) of the desired name. → **OK**
 4. [▲]/[▼]: Select the desired item. → **OK**^{*2}
 5. Press [▲] or [▼] to select the desired phone number.
 6. Go off-hook.
 7. Go on-hook to end the call.
- *1 If only Remote Phonebook is permitted, this step is skipped.
 *2 If you push and hold [▲]/[▼], the next/previous items will be displayed automatically.

Note

- If the Remote Phonebook is not permitted, this feature cannot be used. Contact your administrator for further information.
- For details about making a call using the Remote Phonebook, see "Searching for an Item in the Remote Phonebook", Page 43.

Making a Multicast Voice Paging call

When you make a paging call, the voice will be heard through the speaker phone of the other telephones.

[In standby mode]

1. **Menu**
 2. [▲]/[▼]: "Paging"^{*1} → **OK**
 3. [▲]/[▼]: Select a desired channel group. → **OK**
- *1 Paging is available only when the feature is enabled. Contact your administrator for further information.

Receiving Calls

- You can select the ringer for each type of incoming call. See “Incoming Option”, Page 59.
- You can also use Auto Answer to answer a call. See “Answer Option”, Page 59.
- The volume of the ringer can be adjusted, or turned off. See “Adjusting the Ringer Volume or Turning the Ringer Off”, Page 23.
- If you attach a headset while receiving an incoming call, ringing will be heard from the speaker.

Caller ID

If an outside call that contains Caller ID information (a caller’s name and telephone number) is received, this information will be logged in the incoming call log and displayed on the LCD.

If a call from a number matching a number entered in the phonebook is received, the name registered in the phonebook for that number will be displayed along with the number.

If caller information is sent by the phone system and there is also information stored in the phonebook for the same number, the information stored in the phonebook will be displayed.

Answering Calls

To answer an incoming call

1. Go off-hook.*1

*1 When the handset is already off-hook, press and release the hook switch.

Note

- When a call is received while another call is on hold, pressing and releasing the hook switch will answer the call.

To answer an incoming call on a specific line

1. Press the corresponding [*/[LINE] key.

Note

- When a program key is assigned as a Line key, this feature is available.
- Line keys with incoming calls will be flashing blue rapidly.
- You can select the ringer pattern for each type of incoming call. For details, see “Incoming Option”, Page 59.

To reject an incoming call

1. While an incoming call is ringing, press **Reject**.
2. The call will be rejected, and the telephone will return to standby mode.

Note

- Calls from specific numbers can be automatically rejected. For details, see “Incoming call barring (Caller ID service users only)”, Page 46.

Hands-free Mode

In hands-free mode, you can talk and hear the other party in a conversation without using the handset. This mode is useful for performing other tasks during a conversation, such as writing.

Enabling hands-free mode

If you press \mathbb{P} /[SP-PHONE] in standby mode, you can enable hands-free mode.

During a conversation using a headset, you can enable hands-free mode by pressing \mathbb{P} /[SP-PHONE].

Canceling hands-free mode

You can cancel hands-free mode in one of the following ways:

- During a conversation in hands-free mode, go off-hook.
- While you are talking in hands-free mode and a headset is attached to the unit, press \mathbb{Q} /[HEADSET] to continue the conversation using the headset.

During a Conversation

Transferring a Call (Call Transfer)

You can transfer a call to another destination (extension or outside party).

To transfer

1. Press **↶/↷/**[TRANSFER] during a conversation.
2. Dial the party you want to transfer to. → **Call**
3. Wait until the other party answers to announce the transfer.
4. Go on-hook.

Note

- To return to the call before the transfer destination answers, press **⊗**[CANCEL].

To do a blind transfer

1. Press **Blind***1 during a conversation.
2. Dial the party you want to transfer to. → **Call**

*1 If blind transfers are not permitted, this soft key is not displayed. Contact your administrator for further information.

Holding a Call

You can put a call on hold by holding the call at your extension.

Holding

To hold the current call

1. **↶/↷/**[HOLD/MESSAGE]

Note

- When a program key is assigned as a Line key, if you press a Line key other than the one for the current call, the call is put on hold or is disconnected depending on the Automatic Call Hold settings. For details, contact your phone system dealer/service provider.

To retrieve a call on hold at your line

1. **↶/↷/**[HOLD/MESSAGE]*1

*1 When the handset is already off-hook, press and release the hook switch.

Note

- When a call is received while another call is on hold, pressing and releasing the hook switch will answer the call.
- You can also retrieve a call on hold by following the step below.
 1. Press the corresponding **↶/**[LINE] key. → **OK**

Holding in a System Parking Zone (Call Park)

You can use this feature as a transferring feature.

When Call Park is permitted, the **Park** soft key is displayed. However, the Call Park feature number must be set beforehand. Also, depending on your phone system, you may need to enter a parking zone

number to retrieve a parked call. The feature depends on your phone system. Contact your administrator for further information.

To set

1. **Park**

To retrieve (Call Park Retrieve)

[In standby mode]

1. Enter the Call Park Retrieve feature number.
2. Go off-hook.

Note

- Depending on the telephone system, the **Park** soft key might blink to show that the line has a parked call. In this case, you can retrieve the call by pressing the blinking **Park** soft key. However, to retrieve a parked call using the soft key, the Call Park Retrieve feature number must be set beforehand. Contact your administrator for further information.

Talking to Two Parties Alternately (Call Splitting)

When talking to one party while the other party is on hold, you can swap the calls back and forth (alternately).

To alternate between the parties leaving one party on hold temporarily

1. Press **↵/☒/☒/☒/[HOLD/MESSAGE]** during a conversation.
2. Dial the other party's extension number. → **Call**
3. After talking to the other party, press **↵/☒/☒/☒/[HOLD/MESSAGE]**.
4. Talk to the original party.

Three-party Conference

During a conversation, you can add an additional party to your call and establish a conference call.

Note

- Your phone system may support advanced conference features, such as conference calls with four or more parties. In this case, the procedures for handling a conference call may be different from those explained in this section. For details, contact your phone system dealer/service provider.

Making a Conference Call

1. Press **△/[CONF]** during a conversation.
2. Dial the party you want to add to the conversation. → **Call**
3. **△/[CONF]**

Removing a Party from the Conference

During a conference, you can remove other parties from the conference. However, this operation is available only during conference calls you initiate.

1. During a conference call, press **↵/☒/☒/☒/[HOLD/MESSAGE]**.
2. Press the corresponding **[-/[LINE]** key for the party you want to disconnect.*1 → **OK**
3. Talk to the party and go on-hook to end the call.
4. Go off-hook and talk to the remaining party.

*1 When a program key is assigned as a Line key, this feature is available.

During a Conversation

Note

- To reestablish the conference without removing either party, press Δ /[CONF] after step 2 whether on-hook or off-hook.

Ending a Conference Call

To end the conference call, go on-hook.

Mute

You can disable the microphone or the handset to consult privately with others in the room while listening to the other party on the phone through the speaker or the handset.

To set/cancel

1. MUTE /[MUTE/AUTO ANS]

Note

- When the  icon is blinking on the LCD, Mute is on.
- During Mute, even if you switch from/to speakerphone, Mute will continue.
- During Mute, even if you connect/disconnect a headset, Mute will continue.

Call Waiting

During a conversation, if a second call arrives, you will hear a call waiting tone. You can answer the second call by disconnecting or holding the current call.

This is an optional telephone company service. You can receive a call waiting tone and the caller's information. For details, contact your phone system dealer/service provider.

To disconnect the current call and then talk to the new party

1. Go on-hook.
2. Go off-hook.

To hold the current call and then talk to the new party

1. **Answer**

Note

- You can also answer the call by pressing HOLD /[HOLD/MESSAGE].

Off-hook Monitor

During a two-party conversation with the corded handset, you can allow other people to listen to the conversation through the speaker while you continue the conversation using the corded handset.

To start/To cancel

1. Press SP-PHONE /[SP-PHONE] during a conversation.

Note

- When off-hook monitor is active, replacing the corded handset to its cradle enables hands-free mode.



Call Forwarding/Do Not Disturb

You can have incoming calls automatically forwarded to another destination. You can also have incoming calls rejected (Do Not Disturb).

To access the FWD/DND settings

1. **Menu**
2. [▲]/[▼]: "FWD/DND" → **OK**
3. If the unit has multiple lines, press [▲] or [▼] to select the desired line. → **OK**
4. [▲]/[▼]: Select the type of FWD or DND setting to apply. → **OK**
 The settings are as follows:
 - DND: Enable Do Not Disturb
(All incoming calls are automatically rejected.)
 - Fwd (All): Enable Forward All Calls
(All incoming calls are forwarded.)
 - Fwd (Busy): Enable Forward Busy
(Incoming calls are forwarded only when your extension is in use.)
 - Fwd (NA): Enable Forward No answer
(An incoming call is forwarded if you do not answer the call within a certain amount of time.)
5. If a Forward setting is selected, enter a new forward destination number, or confirm and modify a previously set forward destination number. → **OK**





Note

- When Call Forwarding and/or Do Not Disturb is enabled,  / **Fwd** and/or  / **DND** appears on the display in standby mode.

Listening to Voice Mail Messages

When you receive a voice message, "Voice MSG" is displayed. You can check your new messages by accessing your mailbox.

[In standby mode]

1. Press and hold  /  /  /  / [HOLD/MESSAGE].
2. [▲]/[▼]: Select the line on which  is displayed. → **OK**

Note

- Step 2 is not necessary if only one line is configured on the telephone.

Using the Phonebook

The KX-HDV130 has 2 types of phonebook.

1. Local Phonebook

This Phonebook is stored in the telephone.

2. Remote Phonebook

If your telephone company provides the remote phonebook service, you can use it. For details, contact your phone system dealer/service provider.

	Local Phonebook	Remote Phonebook
Storing new items	✓	—
Editing stored items	✓	—
Deleting store items	✓	—
Searching the phonebook by name	✓	✓
Searching the phonebook by category	✓	—
Phone numbers for each item	Up to 5	Up to 5*1
Private Ring	✓	—

*1 This number depends on the service being used.

Using the Local Phonebook

You can store up to 500 phone numbers in the telephone along with names for easy access. You can also set unique ringer patterns for different categories to identify incoming calls. All Phonebook items are stored in alphabetical order. For security purposes, you can lock the Phonebook.

- To search for an item in the Phonebook, see “Searching for an Item in the Local Phonebook”, Page 40.
- To refer to another phonebook that can contain more than 500 items, see “Using the Remote Phonebook”, Page 43.

Note

- We recommend that backups are made of the phonebook data, in case the data becomes unrecoverable due to product malfunction.
- A single entry (i.e., name) can have multiple phone numbers. Since the phonebook capacity is limited by the number of stored phone numbers, storing multiple phone numbers in an entry decreases the maximum number of entries.
- In addition, if your phone service provider supports the following phonebook data, you can download it via the network.
In a name that exceeds 24 characters, the exceeding characters will be deleted.
Phone numbers that exceed 32 digits are invalid.

Private Ring

You can organize entries in the Phonebook into one of 9 Private Ring Categories. It is possible to set a different ringer pattern*1 for each category. When the displayed Caller ID*2 matches a phone number or name stored in the Phonebook, the telephone rings according to the Private Ring Category settings.

*1 For Ringer patterns, see “Incoming Option”, Page 59.

*2 For Caller ID information, see “Caller ID”, Page 30.

Storing an Item in the Local Phonebook

Storing a New Item

[In standby mode]

1. **Menu**
2. [▲]/[▼]: "New Phonebook" → **OK**
3. Enter a name (max. 24 characters). → **OK**
4. [▲]/[▼]: Select a phone number type (**1** to **5**). → **OK**
5. Enter the phone number (max. 32 digits). → **OK**
6. Repeat steps 4 and 5 to add additional phone number types.
7. [▲]/[▼]: "Category Off" → **OK**
8. Select a category. → **OK**
9. To select a default number for the entry, press [▲] or [▼] to select "Default TEL No". → **OK**
10. [▲]/[▼]: Select the number to use as the default number. → **OK**
11. **Save**

Note

- Steps 7 and 8 can be omitted if you do not want to assign a category.

Using the Phonebook

- Steps 9 and 10 can be omitted if you do not want to assign a default number. (The first number entered for an entry will automatically be assigned as the default number.)
 - The valid digits are "0" through "9", "*", "#", "+", "P".
 - If an item with the same name and number exists, the new information added will be merged with the existing item.
 - To enter characters, see "Entering Characters", Page 25.
-

Storing an Item Using the Dialing

You can dial a number first and then add it as a phonebook entry.

[In standby mode]

1. Dial a number.
2. 
3. Enter a name (max. 24 characters). → **OK**
4. [▲]/[▼]: Select a phone number type (**1** to **5**). → **OK**
5. Edit the phone number if desired. → **OK**
6. Repeat steps 4 and 5 to add additional phone number types.
7. [▲]/[▼]: "Category Off" → **OK**
8. Select a category. → **OK**
9. To select a default number for the entry, press [▲] or [▼] to select "Default TEL No" → **OK**
10. [▲]/[▼]: Select the number to use as the default number. → **OK**
11. **Save**

Note

- Steps 7 and 8 can be omitted if you do not want to assign a category.
 - Steps 9 and 10 can be omitted if you do not want to assign a default number. (The first number entered for an entry will automatically be assigned as the default number.)
 - The valid digits are "0" through "9", "*", "#", "+", "P".
 - If an item with the same name and number exists, the new information added will be merged with the existing item.
 - To enter characters, see "Entering Characters", Page 25.
-

Storing an Item Using the Incoming or Outgoing Call Log

You can add a number listed in the Incoming or Outgoing Call Log to the Local Phonebook.

[In standby mode]

1. Display the incoming or outgoing call log. For details, see Page 23.
 2. [▲]/[▼]: Select the desired item. → **Menu**
 3. [▲]/[▼]: "Save Phonebook" → **OK**
 4. Edit the name if desired. → **OK**
 5. [▲]/[▼]: Select a phone number type (**1** to **5**). → **OK**
 6. Edit the phone number if desired. → **OK**
 7. Repeat steps 5 and 6 to add additional phone number types.
 8. [▲]/[▼]: "Category Off" → **OK**
 9. Select a category. → **OK**
 10. To select a default number for the entry, press [▲] or [▼] to select "Default TEL No" → **OK**
-

11. [▲]/[▼]: Select the number to use as the default number. → **OK**

12. **Save**

Note

- Steps 8 and 9 can be omitted if you do not want to assign a category.
- Steps 10 and 11 can be omitted if you do not want to assign a default number. (The first number entered for an entry will automatically be assigned as the default number.)
- The valid digits are "0" through "9", "✳", "☎", "✚", "P".
- If an item with the same name and number exists, the new information added will be merged with the existing item.
- To enter characters, see "Entering Characters", Page 25.

Editing a stored item in the Local Phonebook

Editing a Stored Item

[In standby mode]

1. 

2. [▲]/[▼]: "Phonebook" → **OK***1

3. Enter the name or the first character(s) of the desired name. → **OK**

4. [▲]/[▼]: Select the desired name, phone number, category or default telephone number. → **Menu**

5. [▲]/[▼]: "Edit" → **OK**

6. Edit the data as necessary. → **OK**

7. Repeat step 4 to 6 and edit the items you want to change.

8. **Save**

*1 Depending on your service provider, there are cases where this menu does not appear. In this case, step 2 is skipped.

Note

- To change a character or digit, press [◀] or [▶] to highlight it, press **Clear** to delete it, and then enter the new character or digit.
- To clear an entire line, press and hold **Clear** for more than 1 second.
- To move the cursor to the left or right, press [◀] or [▶], respectively.
- For details about entering characters, see "Entering Characters", Page 25.

Editing Category Names

You can edit the names of the categories in the phonebook.

[In standby mode]

1. **Menu**

2. [▲]/[▼]: "Basic Settings" → **OK**

3. [▲]/[▼]: "Display Option" → **OK**

4. [▲]/[▼]: "Category Name" → **OK**

5. [▲]/[▼]: Select the desired category number (1–9). → **OK**

6. Enter a name for the category (max. 13 characters). → **OK**

7. Repeat steps 5 and 6 for each category name to edit.

Using the Phonebook

Note

For details about entering characters, see “Entering Characters”, Page 25.

Deleting a Stored Item in the Local Phonebook

Deleting a Stored Item

[In standby mode]

1. 
2. [▲]/[▼]: "Phonebook"*1 → **OK**
3. Enter the name or the first character(s) of the desired name. → **OK**
4. [▲]/[▼]: Select the desired item.
5. **Menu**
6. [▲]/[▼]: "Delete" → **OK***2
7. [▲]/[▼]: "Yes" → **OK**

*1 Depending on your service provider, there are cases where this menu does not appear. In this case, step 2 is skipped.

*2 To delete all items, select "Delete All" instead of "Delete".

Searching for an Item in the Local Phonebook

You can search for an item in the phonebook by following the steps below.

Searching by Name

You can also search for an item in the phonebook by entering a name:

[In standby mode]

1. 
2. [▲]/[▼]: "Phonebook"*1 → **OK**
3. Enter the name or the first character(s) of the desired name. → **OK**
4. [▲]/[▼]: Select the desired item. → ←/[ENTER]*2
5. [▲]/[▼]: Select the desired phone number.
6. To make a call, go off-hook.

*1 If only Local Phonebook is permitted, this step is skipped.

*2 If you push and hold [▲]/[▼], the next/previous items will be displayed automatically.

Searching by Category

If items in the phonebook have been assigned categories, you can search by category.

[In standby mode]

1. 
2. [▲]/[▼]: "Phonebook"*1 → **OK**
3. **#**
4. [▲]/[▼]: Select a category. → **OK**
5. Enter the name of the item in the category. → **OK**
6. [▲]/[▼]: Select the desired item.
7. To make a call, go off-hook.

*1 If only Local Phonebook is permitted, this step is skipped.

Searching by pressing Dial Keys

You can also search for an item in the phonebook by pressing multiple dial keys when the phonebook list is displayed:

1. Press the dial keys to enter the first character(s) of the desired name in accordance with the character tables.*1 → **OK**

*1 For details about the characters assigned to the dial keys, see the following table.

Suffix	NE/X/SX/C/(none)	NE/X/SX	RU
Keys	ABC (Latin)	ABГ (Greek)	АБВ (Cyrillic)
[1]	Æ→Ж→1	Æ→Ж→1	А→Б→В→Æ→Ж→1
[2]	A→B→C→2	A→B→Г→2	Г→Д→Е→Ё→2→A→B→C→2
[3]	D→E→F→3	Δ→E→Z→3	Ж→3→И→Й→3→D→E→F→3
[4]	G→H→I→4	Η→Θ→I→4	К→Л→М→4→G→H→I→4
[5]	J→K→L→5	Κ→Λ→M→5	Н→О→П→5→J→K→L→5
[6]	M→N→O→6	N→Ξ→O→6	Р→С→Т→6→M→N→O→6
[7]	P→Q→R→S→7	Π→P→Σ→7	У→Ф→Х→7→P→Q→R→S→7
[8]	T→U→V→8	Τ→Υ→Φ→8	Ц→Ч→Ш→8→T→U→V→8
[9]	W→X→Y→Z→9	Χ→Ψ→Ω→9	Щ→Ъ→Ы→Ь→9→W→X→Y→Z→9
[0]	0→Space	0→Space	Э→Ю→Я→Space

- Pressing a key repeatedly will cycle through the characters associated with that key. For example, to enter the letter "C" in Latin Mode, press [2] 3 times.
- The illustrations of the keys in the table may differ in appearance from the actual keys on the telephone.

Example: To enter "ANNE" in Latin Mode.

[2] → [6] → [6] → [▶] → [6] → [6] → [3] → [3]

Note

- Availability depends on your phone system. Contact your administrator for further information.

Locking the Local Phonebook

You can lock/unlock the phonebook while in standby mode. If no password has been set, you cannot lock the phonebook. For details about setting the password, see "Setting the Password", Page 24.

Locking/Unlocking the Phonebook

To lock

1. Press and hold  for more than 2 seconds.  will be displayed.*1

To unlock

1. Press and hold  for more than 2 seconds.
2. Enter your password.*2
3. To return to standby mode, press ⊗/[CANCEL].

Unlocking the Phonebook Temporarily

1. 
2. Enter your password.*2

Using the Phonebook

*1 The call log is also locked.

*2 If you enter an incorrect password 3 times, you cannot enter another password for approximately 30 seconds.

Using the Remote Phonebook

You can refer to the Remote Phonebook in addition to the Local Phonebook, if the Remote Phonebook is available.

Note

We recommend setting this feature with your administrator. Contact your administrator for further information.

Searching for an Item in the Remote Phonebook

Searching by Name

[In standby mode]

1. 
 2. [▲]/[▼]: "Remote Phonebook"^{*1}. → **OK**
 3. Enter the name or the first character(s) of the desired name. → **OK**
 4. [▲]/[▼]: Select the desired item. → **OK**^{*2}
 5. [▲]/[▼]: Select the desired phone number.
 6. To make a call, go off-hook.
- *1 If only Remote Phonebook is permitted, this step is skipped.
 *2 If you push and hold [▲]/[▼], the next/previous items will be displayed automatically.

ECO Mode

Enabling this mode reduces the amount of electricity consumed by the unit.

Note

- When ECO mode is enabled, the "Link Speed" setting (Page 65) changes as follows:
 - Link Speed: "10M/Full"
 - PC port cannot be used
- When the ECO mode setting is changed, the unit will restart.
- When ECO mode is enabled, **ECO** is displayed while the unit is in standby mode.

Setting ECO Mode

[In standby mode]

1. **Menu**
 2. [▲]/[▼]: "ECO Mode" → **OK**
 3. [▲]/[▼]: "On"^{*1} → **OK**
- *1 To disable ECO mode, select "Off" (default).

Customizing the Telephone

Changing the Telephone's LCD Display

You can change what is displayed on the telephone's LCD while the telephone is in standby mode.

1. **Menu**
2. [▲]/[▼]: "Basic Settings" → **OK**
3. [▲]/[▼]: "Display Option" → **OK**
4. [▲]/[▼]: "Standby Display" → **OK**
5. [▲]/[▼]: Select the desired item. → **OK**

Hot Keys

By assigning phone numbers to dial keys, you can make a call by pressing and holding a dial key.

- "Hot Key Dialing", Page 27

Assigning Hot Keys From Phonebook

You can assign a phone number stored in the Local Phonebook to a key to be used as a Hot Key.

1. In standby mode, press and hold a dial key (0–9) for more than 1 second.
2. **Menu**
3. [▲]/[▼]: "Copy from P.book". → **OK**
4. Enter the desired name. → **OK**
5. [▲]/[▼]: Select a number → **OK**
6. "Save" → **OK**

Note

- For details about searching for an item in the phonebook, see "Searching for an Item in the Local Phonebook", Page 40.

Editing Hot Keys

1. In standby mode, press and hold a dial key (0–9) for more than 1 second.
2. **Menu**
3. [▲]/[▼]: "Edit" → **OK**
4. Edit the Hot Key Name, if necessary. → **OK**
5. Edit the Hot Key Number, if necessary. → **OK**
6. "Save" → **OK**

Deleting a Hot Key

1. In standby mode, press and hold the dialing key assigned as a Hot Key for more than 1 second.*1
2. **Menu**
3. [▲]/[▼]: "Delete" → **OK***2
4. [▲]/[▼]: "Yes" → **OK**

- *1 While the Hot Key's information is displayed, you can press [▲] or [▼] to select another Hot Key number.
- *2 To delete all items, select "Delete All" instead of "Delete".

Selecting the Type of Hot Key Dialing

You can select one of 2 types of Hot Key Dialing for each assigned Hot Key.

1. In standby mode, press and hold a dial key (0–9) for more than 1 second.
2. **Menu**
3. [▲]/[▼]: "Automatic Call" → **OK**
4. "Manual"/"Auto" → **OK**
 - Manual:
Press and hold the dialing key (0–9) assigned as a Hot Key for more than 1 second, and then go off-hook. For details, see "Hot Key Dialing", Page 27.
 - Auto:
Pressing and holding an assigned Hot Key for the set number of seconds will dial that Hot Key's assigned number immediately.

Note

- To select the number of seconds before the call is automatically made, see "Hot Key Time" in "Key Option", Page 59.

Changing the Program Keys

Each of the 2 program keys can be assigned one of the following functions.

- One Touch Dial
Used to dial a previously set phone number with one touch.
- BLF
Busy Lamp Field. Used to monitor the status of another phone using the LED of the program key.

Status		Meaning
Color	Light pattern	
Red	Off	Available
	On	Unavailable
	Quick Flashing	Ringing

- Line
Used to seize a line or confirm its status.
- ACD*1
Used to login/logout of an Automatic Call Distribution Group, or change the phone's status from unavailable → wrap up → available.
The color of each key's LED indicates the status of the key.

Status		Meaning	
Color	Light pattern	Login key	Wrapup key
Red	Off	Logged In	Available
	On	Logged Out	Unavailable
	Slow Flashing	—	Wrap Up

- Call Forward
Used to forward incoming calls to the extension assigned to the key.

Customizing the Telephone

[In standby mode]

1. **Menu**
 2. [▲]/[▼]: "Basic Settings" → **OK**
 3. [▲]/[▼]: "Key Option" → **OK**
 4. [▲]/[▼]: "Program Key" → **OK**
 5. [▲]/[▼]: Select the key to change. → **OK**
 6. [▲]/[▼]: Select the new item to assign. → **OK**
- *1 This item is displayed only when the feature is enabled. Contact your administrator for further information.

Block anonymous calls

This feature allows the unit to reject calls when the unit receives a call without phone number. The default setting is "Off".

IMPORTANT

- We recommend setting with your administrator. Contact your administrator for further information.
- This feature is not available on shared lines.

1. **Menu**
2. [▲]/[▼]: "Basic Settings" → **OK**
3. [▲]/[▼]: "Call Settings" → **OK**
4. [▲]/[▼]: "Block Anonymous" → **OK**
5. [▲]/[▼]: Select a desired line. → **OK**
6. [▲]/[▼]: "On"/"Off" → **OK**

Incoming call barring (Caller ID service users only)

This feature allows the unit to reject calls from specified phone numbers that you do not want to answer such as junk calls.

When a call is received, the unit does not ring while the caller is being identified. If the phone number matches an entry in the call barred list, the unit rejects the call.

Storing unwanted callers

You can store up to 30 phone numbers in the call barred list by using the caller list or by entering the numbers directly.

1. **Menu**
2. [▲]/[▼]: "Basic Settings" → **OK**
3. [▲]/[▼]: "Call Settings" → **OK**
4. [▲]/[▼]: "Block Caller ID" → **OK**
5. [▲]/[▼]: Select a blank line. → **Menu**
6. [▲]/[▼]: "Edit" → **OK**
7. Enter the phone number (32 digits max.). → **OK**

Editing the phone numbers to reject

1. **Menu**
2. [▲]/[▼]: "Basic Settings" → **OK**
3. [▲]/[▼]: "Call Settings" → **OK**
4. [▲]/[▼]: "Block Caller ID" → **OK**
5. [▲]/[▼]: Select a desired phone number. → **Menu**
6. [▲]/[▼]: "Edit" → **OK**
7. Enter the phone number. → **OK**

Deleting the phone numbers to reject

1. **Menu**
2. [▲]/[▼]: "Basic Settings" → **OK**
3. [▲]/[▼]: "Call Settings" → **OK**
4. [▲]/[▼]: "Block Caller ID" → **OK**
5. [▲]/[▼]: Select a desired phone number. → **Menu**
6. [▲]/[▼]: "Delete Number"^{*1} → **OK**
7. [▲]/[▼]: "Yes" → **OK**

*1 To delete all items, select "Delete All No." instead of "Delete Number".

Making an anonymous call

Before making a call, specify the following:

IMPORTANT

- We recommend setting with your administrator. Contact your administrator for further information.

1. **Menu**
2. [▲]/[▼]: "Basic Settings" → **OK**
3. [▲]/[▼]: "Call Settings" → **OK**
4. [▲]/[▼]: "Anonymous Call" → **OK**
5. [▲]/[▼]: Select a line. → **OK**
6. [▲]/[▼]: "On"/"Off" → **OK**

Changing the Basic Settings

To select the main item in standby mode

1. **Menu**
2. [▲]/[▼]: "Basic Settings" → **OK**
3. [▲]/[▼]: Select the main item. → **OK**

Main Item	Sub Item		Page
Incoming Option	Ringer Volume	Ringer Type	Page 59

Customizing the Telephone

Talk Option	Speaker Volume	Handset Volume	Headset Volume	Page 59
Answer Option	Auto Ans Device	Auto Ans Delay		Page 59
Key Option	Program Key	Soft Key Edit	Soft Key Name	Page 59
	Hot Key Time			
Display Option	Language	Backlight	LCD Contrast	Page 61
	Standby Display	Category Name	Date Format	
	Time Format			
Key Tone				Page 62
Call Settings	Block Anonymous	Anonymous Call	Block Caller ID	Page 62
	Anywhere*1	Remote Office*1	SimultaneousRing*1	
	System Lock			
Other Option	Change Password	Embedded Web		Page 62

*1 This item is displayed only when the feature is enabled. Contact your administrator for further information.

Changing the System Settings

IMPORTANT

- The feature depends on your phone system. Contact your administrator for further information.

[In standby mode]

1. **Menu**
2. [▲]/[▼]: "System Settings" → **OK**
3. [▲]/[▼]: Select the main item. → **OK**

Main Item	Sub Item			Page
Status	Line Status	Firmware Version	IP Mode	Page 64
	IPv4 Settings	IPv6 Settings	MAC Address	
	LLDP	VLAN		
Network Settings	IP Mode Select	IPv4 Settings	IPv6 Settings	Page 64
	LLDP	VLAN	Link Speed	
System Settings	Set Time & Date*1	Authentication	Access Code	Page 65
	Xsi Setting*2	UC Setting*2	Restart	

*1 Availability depends on your phone system. Contact your administrator for further information.

*2 This item is displayed only when the feature is enabled. Contact your administrator for further information.

Web User Interface Programming

The product provides a Web-based interface for configuring various settings and features, including some that are not programmable directly. The following list contains some useful features that are programmable through the Web user interface.

Contact your administrator for further information.

- Language Settings (IP Phone/Web)
- User Password (for access to Web user interface)

- Default Line for Outgoing
- Call Rejection Phone Numbers
- Call Features
 - Enable Anonymous Call
 - Enable Block Anonymous Call
 - Enable Do Not Disturb
 - Enable Call Forwarding Always
 - Forwarding Number (Always)
 - Enable Call Forwarding Busy
 - Forwarding Number (Busy)
 - Enable Call Forwarding No Answer
 - Forwarding Number (No Answer)
 - Ring Counts (No Answer)
- Hotline Number
- Program Key
- Phonebook Import and Export

Note

- Each time you want to access the Web user interface, you must enable Web programming (Embedded Web). See “Other Option”, Page 62.

Installation and Setup

Note

- Panasonic assumes no responsibility for injuries or property damage resulting from failures arising out of improper installation or operation inconsistent with this documentation.

WARNING

- To reduce the risk of fire or electric shock, do not overload AC outlets and extension cords.
- Completely insert the AC adaptor/power plug into the AC outlet. Failure to do so may cause electric shock and/or excessive heat resulting in a fire.
- Regularly remove any dust, etc. from the AC adaptor/power plug by pulling it from the power outlet, then wiping with a dry cloth. Accumulated dust may cause an insulation defect from moisture, etc. resulting in a fire.

Attaching the Stand

Attach the stand to the desk phone.

1. Insert the stand into the slots located in the unit.
2. Gently rotate the stand in the direction indicated until it is fixed.

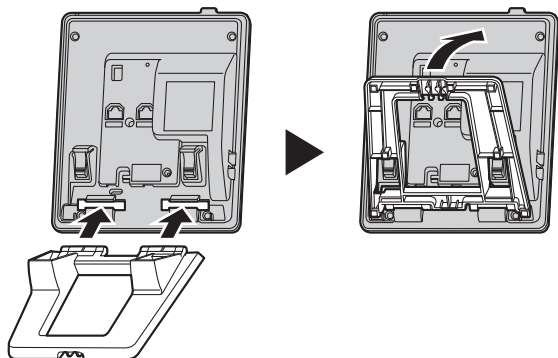

Adjusting the Stand Position

Push the PUSH marks in the direction indicated, with both hands, and tilt and slide the stand until it becomes fixed in the desired position.

- High Position → Low Position

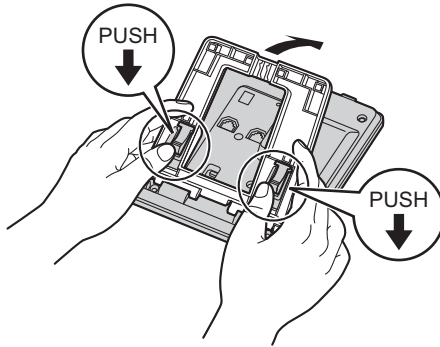

- Low Position → High Position

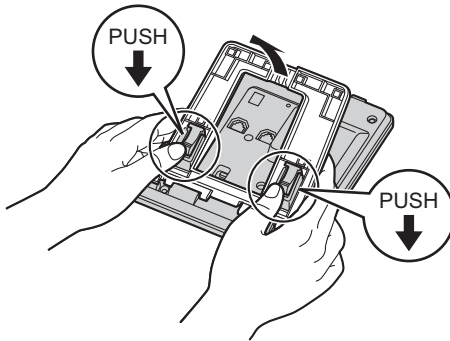

Removing the Stand

Tilt the stand in the direction indicated while pushing the PUSH marks with both hands.

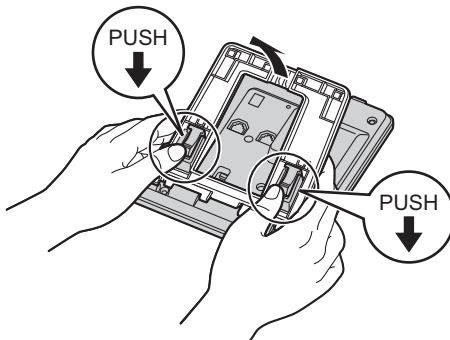

Connections

Connect the Ethernet cable, the Handset Cord and the AC adaptor (Option) to the unit.

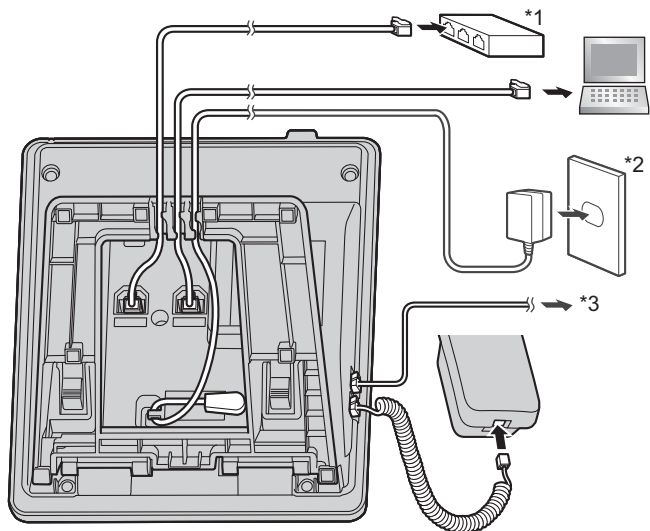

*1 PoE HUB

*2 Optional AC adaptor

*3 Optional headset

For up-to-date information about headsets that have been tested with this unit, refer to the following web sites:

<http://panasonic.net/pcc/support/sipphone/>

- The initial setting for the IP address is "DHCP—Auto". For information about your network environment, contact your administrator. For details, see "Network Settings", Page 64.

When selecting Ethernet cables (not included)

- Use flexible cables without jack covers. Do not use cables with a hard coating that may tear or crack when bent.

To prevent damage to the cables, use cables that do not protrude from the bottom of the base.

Connect the cables as shown in the following illustration.

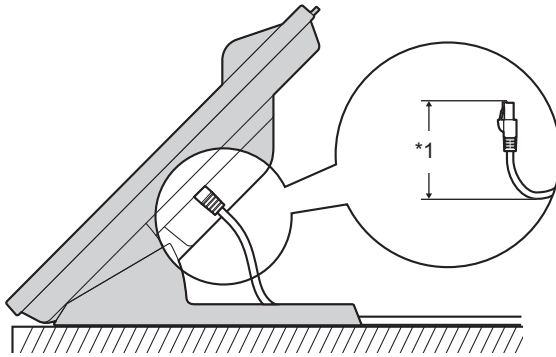

*1 60 mm (2 3/8 in) or less

- Use a straight CAT 5e (or higher) Ethernet cable (not included) that is 6.5 mm (1/4 in) in diameter or less.

When connecting to a switching hub

- If PoE is available, an AC adaptor is not needed.
- This unit complies with the PoE Class 1 standard.

When connecting a PC

- The PC port does not support PoE for connected devices.

When connecting cables and the AC adaptor

- Pass the Ethernet cable and the AC adaptor cord under the stand.

Wall Mounting

Note

- Make sure that the wall and the fixing method are strong enough to support the weight of the unit.
1. Insert the tabs of the wall mounting adaptor into the designated openings in the base, and then slide the wall mounting adaptor in the direction of the arrow until it clicks.

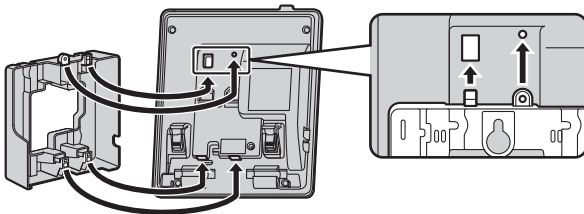

2. Fasten the wall mounting adaptor to the base with the small screw.
(Recommended torque: 0.4 N·m [4.08 kgf·cm/3.54 lbf·in] to 0.6 N·m [6.12 kgf·cm/5.31 lbf·in])
3. Connect the AC adaptor and handset cord.

Installation and Setup

- Drive the large screws into the wall either 83 mm (3 1/4 in) or 100 mm (3 15/16 in) apart, and mount the unit on the wall.

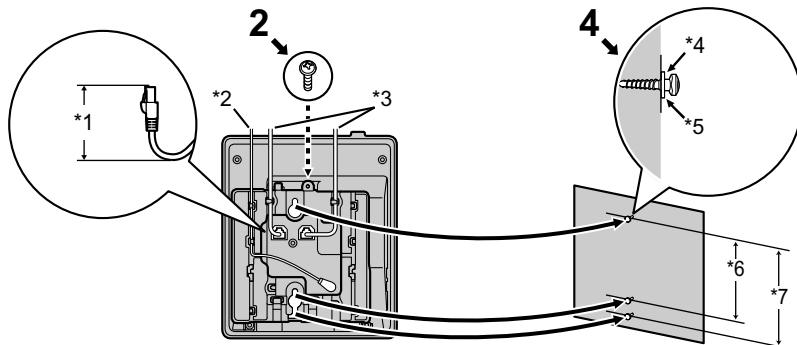

*1 40 mm (1 37/64 in) or less

*2 AC adaptor

*3 Ethernet cables

*4 Washer

*5 Drive the screw to this point.

*6 83 mm (3 1/4 in)

*7 100 mm (3 15/16 in)

- You can find a wall mounting template at the end of this manual.
- When inserting screws, avoid pipes and electrical cables, etc., that may be present/buried.
- The screw heads should not be flush to the wall.
- Certain types of wall may require plugs to be anchored in the wall before the screws are inserted.

Hooking the Handset

To Hook the Handset During a Conversation

- Hook the handset over the top edge of the unit.

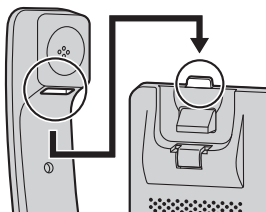

To Lock the Handset Hook when the Unit is Wall Mounted

- Remove the handset hook from the slot.
- Turn it up-side-down.
- Slide the handset hook back into the slot until it locks.

4. Handset is safely hooked when it is in the cradle.

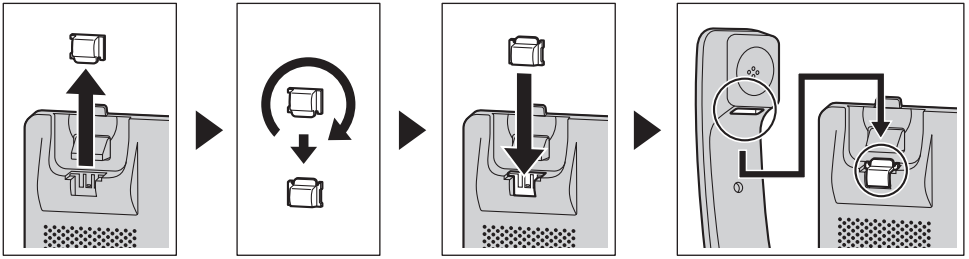

Updating the software

Your phone system dealer may offer new features and improve its software version from time to time. Contact your administrator for further information.

Appendix

Character Mode Table

KX-HDV130 (Suffix: [none]/C)

Keys	ABC (Latin)		0–9 (Numeric)	+ĂĂ (Extended 1)	
	Upper	Lower		Upper	Lower
[1]	Space ¶ & ' () * , - . / 1		1	Space ¶ & ' () * , - . / 1	
[2]	A B C 2	a b c 2	2	Ă Ă Ă ă ă ă Æ B C Ç 2	a à á â ã ä å æ b c ç 2
[3]	D E F 3	d e f 3	3	D Đ E Ę É Ê Ë Ě F 3	d ð e è é ê ë ě f 3
[4]	G H I 4	g h i 4	4	G Ğ H İ Ì Í Î Ï Ĵ 4	g ğ h i ì í î ï ĵ 4
[5]	J K L 5	j k l 5	5	J K L 5	j k l 5
[6]	M N O 6	m n o 6	6	M N Ń O Ó Ô Ö Õ Ø œ 6	m n ń o ó ô ö ø œ 6
[7]	P Q R S 7	p q r s 7	7	P Q R S Ş ß 7	p q r s ş ß 7
[8]	T U V 8	t u v 8	8	T U Û Ü Ü Ů Ű V 8	t u ù ú û ü ů v 8
[9]	W X Y Z 9	w x y z 9	9	W Ŵ X Y Ŷ Z 9	w ŵ x y ŷ z 9
[0]	Space ! ? " ; : + = < > 0		0	Space ! ? " ; : + = < > 0	
[#]	\$ % & @ € £		#	\$ % & @ € £	

- Press [X] before or after entering a character to change between uppercase and lowercase.
- Pressing a key repeatedly will cycle through the characters associated with that key. For example, to enter the letter "C" in Latin Mode, press [2] 3 times.
- Characters that are entered using the [#] key (for example, "\$") cannot be entered when searching the phonebook. See "Searching for an Item in the Local Phonebook", Page 40.
- The illustrations of the keys in the table may differ in appearance from the actual keys on the telephone.

KX-HDV130 (Suffix: NE/X/SX)

Keys	ABC (Latin)	0–9 (Numeric)	ΑΒΓ (Greek)	ĂĂĂ (Extended 1)	ŚŚŚ (Extended 2)
[1]	Space ¶ & ' () * , - . / 1	1	Space ¶ & ' () * , - . / 1		
[2]	A B C 2	2	Α Β Γ 2	Ă Ă Ă ă ă ă Æ B C Ç 2	Ă Ă Ă ă ą B C C Ć 2
	a b c 2		α β γ 2	a à á â ã ä å æ b c ç 2	a á ä å ą b c c ć 2
[3]	D E F 3	3	Δ Ε Ζ 3	D Đ E Ę É Ê Ë Ě F 3	D Ď E Ě Ę ě F 3
	d e f 3		δ ε ζ 3	d ð e è é ê ë ě f 3	d đ e é ě ě f 3

Keys	ABC (Latin)	0-9 (Numeric)	ΑΒΓ (Greek)	ÄÄÄ (Extended 1)	ŠŠŠ (Extended 2)
[4]	GHI4	4	ΗΘΙ4	G Ğ H İ İ İ İ İ İ İ 4	GHIÍ4
	ghi4		ηθι4	g ğ h i i i i i i i 4	ghií4
[5]	JKL5	5	ΚΛΜ5	JKL5	JKLĹĹĹ5
	jkl5		κλμ5	jkl5	jkĺĺĺ5
[6]	MNO6	6	ΝΞΟ6	MNÑOÒÓÔ ÕÖøŒ6	MNŃŃŃOÓŎ Ŏ6
	mno6		νξο6	m n ñ o ò ó ô õ ö ø œ 6	m n ń Ń o ó ô õ ö ø œ 6
[7]	PQRS7	7	ΠΡΣ7	PQRSŞß7	PQRŘŘŠŠŠ7
	pqrs7		πρσ7	p q r s ş ß 7	p q r ř ř š š š 7
[8]	TUV8	8	ΤΥΦ8	TUÙÚÚÛÜŮV8	TṬṬUÚÚŮŮV8
	tuv8		τυφ8	t u ù ú ú ü ů v 8	t ṭ ṭ u ú ú ů ů v 8
[9]	WXYZ9	9	ΧΨΩǾ9	WŴXYŶZ9	WXYŸŸZŽŽŽ9
	wxyz9		χψωϝ9	w ŵ x y ŷ z 9	w x y ŷ ŷ z ž ž ž 9
[0]	Space ! ? " : ; + = < > 0	0	Space ! ? " : ; + = < > 0		
[#]	\$ % & @ € £	#	\$ % & @ € £		

- Press [X] before or after entering a character to change between uppercase and lowercase.
- Pressing a key repeatedly will cycle through the characters associated with that key. For example, to enter the letter "C" in Latin Mode, press [2] 3 times.
- Characters that are entered using the [#] key (for example, "\$") cannot be entered when searching the phonebook. See "Searching for an Item in the Local Phonebook", Page 40.
- The illustrations of the keys in the table may differ in appearance from the actual keys on the telephone.

KX-HDV130 (Suffix: RU)

Keys	АБВ (Cyrillic)	0-9 (Numeric)	ABC (Latin)	ÄÄÄ (Extended 1)	ŠŠŠ (Extended 2)
[1]	А Б В Space ✳ + - / = < > 1 а б в Space ✳ + - / = < > 1	1	Space Ꞁ & ' () ✳, - . / 1		
[2]	ГДЕЁ2	2	ABC2	Ä Ä Ä Ä Ä Ä Ä Æ B C Ç 2	Ä Ä Ä Ä Ä B C Č Č 2
	гдеё2		abc2	ä ä ä ä ä ä ä æ b c ç 2	ä ä ä ä ä b c č č 2

Appendix

Keys	АБВ (Cyrillic)	0-9 (Numeric)	ABC (Latin)	АĂĂ (Extended 1)	ŠŠŠ (Extended 2)
[3]	ЖЗИЙЗ	3	DEF3	DĎEĚÉĚĚĚF3	DĎEĚĚĚF3
	жзийз		def3	dċeèéèèĚĚf3	dċeèéèĚf3
[4]	КЛМ4	4	GHI4	GĜHIIÍÎÏÏÏIĬ4	GHIÍ4
	клм4		ghi4	gĝhiíîíîîiĭ4	ghií4
[5]	НОП5	5	JKL5	JKL5	JKLĹĹĹ5
	ноп5		jkl5	jkĹ5	jkĹííí5
[6]	РСТ6	6	MNO6	MNŃOÒÓÔ ŎŎøŒ6	MNŃŃOÓŎ Ŏ6
	рст6		mno6	mñňoóóôôô øœ6	mñňňoóóóô6
[7]	УФХ7	7	PQRS7	PQRSŞß7	PQRŘŔSŠŠ7
	уфх7		pqrs7	pqrsşß7	pqrřřsšš7
[8]	ЦЧШ8	8	TUV8	TUÛÚÛÛÛÛV8	TŤŤUÚÚÛÛÛV8
	цчш8		tuv8	tuúúúúúúv8	tťťuúúúúúv8
[9]	ЩЪЫЬ Space!?"'9	9	WXYZ9	WŴXYŶZ9	WXYZŶZŽŽŽ9
	щъыь Space!?"'9		wxyz9	wŵxyŷz9	wxyŷŷzžžž9
[0]	ЭЮЯ Space.,';; ()0	0	Space!?"'; ; += < > 0		
[#]	\$ % & @ € £ Ğ € ĩ Ÿ #	#	\$ % & @ € £		
	\$ % & @ € £ Ğ € ĩ Ÿ #				

- Press [X] before or after entering a character to change between uppercase and lowercase.
- Pressing a key repeatedly will cycle through the characters associated with that key. For example, to enter the letter "C" in Latin Mode, press [2] 3 times.
- Pressing a key repeatedly will cycle through the characters associated with that key. For example, to enter the letter "E" in Cyrillic Mode, press [2] 3 times.
- Characters that are entered using the [#] key (for example, "\$") cannot be entered when searching the phonebook. See "Searching for an Item in the Local Phonebook", Page 40.
- The illustrations of the keys in the table may differ in appearance from the actual keys on the telephone.

Basic Settings Menu Layout

Incoming Option

Sub Item	Description	Setting	Default
Ringer Volume	Adjusts the ringer volume	<input type="checkbox"/> Level 1–8 <input type="checkbox"/> Off	Level 5
Ringer Type ● Line 1–2 ● Private Ring (Category 1–9)	Ringer Pattern Selects the ringtone for each type of call.*1	<input type="checkbox"/> Ringtone 1–19, 25–32	Ringtone 1

*1 The preset melodies in this product are used with permission of © 2010 Copyrights Vision Inc.

Talk Option

Sub Item	Description	Setting	Default
Speaker Volume	Adjusts the speaker volume.	Level 1–8	Level 5
Handset Volume	Adjusts the handset volume.	Level 1–8	Level 5
Headset Volume	Adjusts the headset speaker volume.	Level 1–8	Level 5

Answer Option

Sub Item	Description	Setting	Default
Auto Ans Device	Selects the types of devices that can be answered by Auto Answer.	<input type="checkbox"/> Speaker Phone <input type="checkbox"/> Headset	Speaker Phone
Auto Ans Delay	Selects the number of seconds before a call is automatically answered when Auto Answer is turned on.	0s–20s	6s

Key Option

Sub Item	Description	Setting	Default
Program Key ● Program Key 1–2	Assigns a function to each program key.	<input type="checkbox"/> One Touch Dial <input type="checkbox"/> BLF <input type="checkbox"/> Line <input type="checkbox"/> ACD*1 <input type="checkbox"/> Login <input type="checkbox"/> Wrap Up <input type="checkbox"/> Call Forward	Not stored

Appendix

Sub Item	Description	Setting	Default
Soft Key Edit <ul style="list-style-type: none"> ● Softkey A ● Softkey B ● Softkey C 	Edits the soft keys in the following situations. <ul style="list-style-type: none"> ● Standby ● Talking 	<input type="checkbox"/> Default <input type="checkbox"/> Function Key <ul style="list-style-type: none"> <input type="checkbox"/> FWD/DND*² <input type="checkbox"/> Flash/Recall*³ <input type="checkbox"/> Incoming Log <input type="checkbox"/> Outgoing Log <input type="checkbox"/> Phonebook <input type="checkbox"/> Call Park*¹*³ <input type="checkbox"/> Pause*¹ <input type="checkbox"/> Paging*¹*² <input type="checkbox"/> Hot Key Dial*² 	Not stored
Soft Key Name <ul style="list-style-type: none"> ● Softkey A ● Softkey B ● Softkey C 	Edits the names of the soft keys in the following situations. <ul style="list-style-type: none"> ● Standby ● Talking 	Max. 5 characters	Not stored
Hot Key Time	Selects the number of seconds before a call is automatically made when a Hot Key assigned to "Auto" is pressed and held.	1s–20s	2s

*1 Displayed only when configured on the telephone.

*2 Displayed only when "Standby" is selected.

*3 Displayed only when "Talking" is selected.

Display Option

Sub Item	Description	Setting	Default
Language	Selects the display language. Up to 10 languages can be downloaded from the server or Web as necessary. Contact your administrator for further information.	Suffix: NE/X/SX <input type="checkbox"/> Auto <input type="checkbox"/> English <input type="checkbox"/> Deutsch <input type="checkbox"/> Español <input type="checkbox"/> FRANÇAIS <input type="checkbox"/> Italiano <input type="checkbox"/> Svenska <input type="checkbox"/> Nederlands <input type="checkbox"/> Português <input type="checkbox"/> Čeština	Auto
		Suffix: (none)/C <input type="checkbox"/> Auto <input type="checkbox"/> English <input type="checkbox"/> Español <input type="checkbox"/> FRANÇAIS	Auto
		Suffix: RU <input type="checkbox"/> Auto <input type="checkbox"/> English <input type="checkbox"/> РУССКИЙ <input type="checkbox"/> Українська	Auto
Backlight	Turns the LCD backlight on or off. If "Auto" or "On" is selected, set the brightness of the backlight from Level 1–3.	<input type="checkbox"/> Auto <input type="checkbox"/> On <input type="checkbox"/> Off	Auto
LCD Contrast	Adjusts the contrast of the backlight of the LCD.	Level 1–6	Level 3
Standby Display	Selects what is shown on the display while in standby mode.	<input type="checkbox"/> Phone Number <input type="checkbox"/> Phone No&Name <input type="checkbox"/> Name <input type="checkbox"/> Off	Phone Number
Category Name	Edits the names of the categories.	Max. 13 characters x Category (1–9)	Not stored
Date Format	Selects the format for the date shown on the display in standby mode.	<input type="checkbox"/> DD-MM-YYYY <input type="checkbox"/> MM-DD-YYYY	Suffix: NE/X/SX/RU DD-MM-YYYY
			Suffix: (none)/C MM-DD-YYYY
Time Format	Selects the format for the time shown on the display in standby mode.	<input type="checkbox"/> 12H <input type="checkbox"/> 24H	Suffix: NE/X/SX/RU 24H
			Suffix: (none)/C 12H

Appendix

Key Tone

Sub Item	Description	Setting	Default
Key Tone	Turns the key tone on or off.	<input type="checkbox"/> On <input type="checkbox"/> Off	On

Call Settings

Sub Item	Description	Setting	Default
Block Anonymous	Specifies whether or not to block incoming anonymous calls.	Line 1–2 <input type="checkbox"/> On <input type="checkbox"/> Off	Off
Anonymous Call	Specifies whether or not to make outgoing anonymous calls.	Line 1–2 <input type="checkbox"/> On <input type="checkbox"/> Off	Off
Block Caller ID	Edits/deletes the phone numbers to reject incoming calls.	Line 1–2 –Edit –Delete Number –Delete All No.	Not stored
Anywhere* ¹	Specifies/edits the Xsi's Anywhere settings.	–Anywhere* ² <input type="checkbox"/> On <input type="checkbox"/> Off –Name –Phone Number* ³	—
Remote Office* ¹	Specifies the Xsi's Remote Office setting.	–Remote Office <input type="checkbox"/> On <input type="checkbox"/> Off –Phone Number* ³	—
SimultaneousRing* ¹	Specifies the Xsi's Simultaneous Ring setting.	–SimultaneousRing <input type="checkbox"/> On <input type="checkbox"/> Off –Phone Number* ³	—
System Lock	Selects whether to lock the Call Settings menu.	<input type="checkbox"/> On* ⁴ <input type="checkbox"/> Off	Off

*1 If the Xsi's service is available, you can select this item. Contact your administrator for further information.

*2 Displayed only when editing.

*3 In a phone number that exceeds 32 digits, the exceeding digits will not be displayed.

*4 Password is required (4 digits).

Other Option

Sub Item	Description	Setting	Default
Change Password* ¹ * ²	Changes the telephone password (4 digits) used for unlocking the Phonebook.	Enter Old Password.* ³ * ⁴ ↓ Enter New Password. ↓ Verify New Password.	Not registered

Sub Item	Description	Setting	Default
Embedded Web	Selects whether the web function and the logging function are available or not.	<input type="checkbox"/> On <input type="checkbox"/> Off	Off

- *1 To avoid unauthorized access to this product:
- Set a password that is random and cannot be easily guessed.
 - Change the password regularly.
- *2 Make a note of the password so that you will not forget it.
- *3 If a password has not already been set, you can skip the first step.
- *4 For details about setting the password, see “Setting the Password”, Page 24.

System Settings Menu Layout

Status

Sub Item	Description	Setting	Default
Line Status ● 1–2	Displays the line status.	Registered*1/ Registering*1/(NULL)	—
Firmware Version	Displays the firmware version of the telephone.	—	—
IP Mode	Displays the IP network mode.	IPv4/IPv6/IPv4&IPv6	—
IPv4 Settings	Displays information about IPv4 settings.	–IP Address*2 –Subnet Mask*2 –Default Gateway*2 –DNS*2	—
IPv6 Settings	Displays information about IPv6 settings.	–IP Address*3 –Prefix*3 –Default Gateway*3 –DNS*3	—
MAC Address	Displays the MAC address of the telephone.	—	—
LLDP	Displays the LLDP status.	On/Off	—
VLAN	Displays the VLAN ID and priority.	—	—

*1 If you select this item and press **OK**, the phone number of the selected line is displayed.

*2 If this item is not set, “0.0.0.0” is displayed. If the telephone is not connected to the network, “...” is displayed.

*3 If this item is not set, “0::0” is displayed. If the telephone is not connected to the network, “:.” is displayed.

Network Settings

Sub Item	Description	Setting	Default
IP Mode Select	Changes the network settings of the telephone. Current settings are displayed as a highlight.	–IPv4 –IPv6 –IPv4&IPv6	IPv4
IPv4 Settings	Specifies the IPv4 settings.	<input type="checkbox"/> DHCP <input type="checkbox"/> Auto <input type="checkbox"/> Manual –DNS 1 –DNS 2 <input type="checkbox"/> Static –IP Address –Subnet Mask –Default Gateway –DNS 1 –DNS 2	DHCP–Auto

Sub Item	Description	Setting	Default
IPv6 Settings	Specifies the IPv6 settings.	<input type="checkbox"/> DHCP <input type="checkbox"/> Auto <input type="checkbox"/> Manual –DNS 1 –DNS 2 <input type="checkbox"/> RA –DNS 1 –DNS 2 <input type="checkbox"/> Static –IP Address –Prefix –Default Gateway –DNS 1 –DNS 2	DHCP–Auto
LLDP	Specifies the LLDP settings.	<input type="checkbox"/> PC Port –VLAN ID –Priority <input type="checkbox"/> On <input type="checkbox"/> Off	VLAN ID: 0 Priority: 0 On
VLAN	Specifies the VLAN settings.	<input type="checkbox"/> Enable VLAN <input type="checkbox"/> Yes <input type="checkbox"/> No <input type="checkbox"/> IP Phone –VLAN ID –Priority <input type="checkbox"/> PC –VLAN ID –Priority	Enable VLAN: No IP Phone: VLAN ID: 2 Priority: 7 PC: VLAN ID: 1 Priority: 0
Link Speed	Specifies the Ethernet PHY mode settings.	<input type="checkbox"/> IP Phone <input type="checkbox"/> Auto <input type="checkbox"/> 100M/Full <input type="checkbox"/> 100M/Half <input type="checkbox"/> 10M/Full <input type="checkbox"/> 10M/Half <input type="checkbox"/> PC <input type="checkbox"/> Auto <input type="checkbox"/> 100M/Full <input type="checkbox"/> 100M/Half <input type="checkbox"/> 10M/Full <input type="checkbox"/> 10M/Half	Auto

System Settings

Sub Item	Description	Setting	Default
Set Time & Date* ¹	Specifies the time and date of the telephone.	—	—
Authentication	Specifies the ID and password for HTTP authentication.	–ID* ² –Password* ²	Not stored

Appendix

Sub Item	Description	Setting	Default
Access Code* ³	Specifies the access code to access the redirect server.	Max. 16 characters	Not stored
Xsi Setting* ⁴	Specifies the ID and password for the Xsi service.	Line 1–2 –ID* ² –Password* ²	Not stored
UC Setting* ⁴	Specifies the ID and password for the Broadsoft UC service (IM&P).	–ID* ² –Password* ²	Not stored
Restart* ⁵	Restart the unit.	<input type="checkbox"/> Yes <input type="checkbox"/> No	—

*1 Availability depends on your phone system. Contact your administrator for further information.

*2 Max. 128 characters

*3 This item is displayed only during initial setup.

*4 This item is displayed only when the feature is enabled. Contact your administrator for further information.

*5 The unit will restart even if it is being accessed through the Web user interface or on a call.

Specifications

Item	Specifications
Power Supply	AC adaptor / PoE (IEEE 802.3af)
Power Consumption	PoE Stand-by: approx. 2.2 W (ECO mode off), approx. 1.9 W (ECO mode on) Talking: approx. 2.3 W (ECO mode off), approx. 2.0 W (ECO mode on) AC Adaptor Stand-by: approx. 2.0 W (ECO mode off), approx. 1.3 W (ECO mode on) Talking: approx. 2.1 W (ECO mode off), approx. 1.4 W (ECO mode on)
Maximum Power Consumption	Approx. 2.8 W
Operating Environment	0 °C (32 °F) to 40 °C (104 °F)
Ethernet Port	LAN: 1 (RJ45), PC: 1 (RJ45)
Ethernet Interface	10Base-T/100Base-TX (Auto / 100MB-FULL / 100MB-HALF / 10MB-FULL / 10MB-HALF) Auto MDI / MDIX
Wideband Codec	G.722
Narrowband Codec	G.711a-law / G.711 μ -law / G.729a
Multiple Line	2
LCD Display	Monochrome graphical
LCD Size	132 × 64 pixels, 4 lines
LCD Backlight	3 levels (Always On/Automatic/Always Off)
VoIP Connection Method	SIP
Speaker	1
Microphone	1
Headset Jack	1 (RJ9)
Dimensions (Width × Depth × Height; stand attached)	"High" position: 167 mm × 165 mm × 148 mm (6.57 in × 6.50 in × 5.83 in) "Low" position: 167 mm × 173 mm × 115 mm (6.57 in × 6.81 in × 4.53 in)
Weight (with handset, handset cord and stand)	691 g (1.52 lb)

Troubleshooting

Common Issues and Solutions

General Use



Issue	Possible Cause	Solution
The display is blank.	The unit is not receiving power.	The unit is not designed to function when there is a power failure. Make sure that the device supplying PoE is receiving power and that the Ethernet cable is properly connected. If an AC adaptor is connected, confirm that the AC adaptor is connected and receiving power.
The display is not shown well.	The display's contrast is too low.	Adjust the display's contrast.
The unit is not performing properly.	Cables or cords are not connected properly.	Check all connections.
	Your connection settings are incorrect.	<ul style="list-style-type: none"> Consult your administrator to confirm that your settings are correct. If the problem persists, consult your dealer.
	An error has occurred.	Restart the unit.
I cannot hear a dial tone.	—	Confirm that the LAN cable is properly connected.
I cannot cancel the phonebook lock.	The password you entered was incorrect.	Enter the correct password.
I forgot my password.	—	Consult your administrator or dealer.
The date and time are not correct.	—	Adjust the date and time of the unit.
The Message/Ringer lamp is lit.	You received a voice message while you were on the phone or away from your desk.	Check the voice message.

Making and Receiving Calls

Issue	Possible Cause	Solution
I cannot make calls.	The phone number was entered incorrectly.	<ul style="list-style-type: none"> Confirm that you have entered the phone number of the other party correctly. Consult your administrator or dealer.
	The unit is downloading a firmware update.	You cannot make calls while the unit is downloading updates. Wait for the update to finish, and then try making a call.

Issue	Possible Cause	Solution
	The phonebook list is being imported or exported.	<ul style="list-style-type: none"> ● Wait a few minutes for the operation to complete. ● Confirm with your administrator or dealer.
I cannot make long distance calls.	Your telephone service does not allow you to make long distance calls.	Make sure that you have subscribed to your telephone company's long distance service.
The unit does not ring when a call is received.	The ringer is turned off.	Press the [+] volume key while a call is being received, or change the ringer volume setting.
While talking to an outside party, the line is disconnected.	Your phone system/service may impose a time limit on outside calls.	Consult your dealer to extend the time limit, if necessary.

Sound Quality

Issue	Possible Cause	Solution
The other party cannot hear my voice.	The unit is muted.	Press  /  /[MUTE/AUTO ANS] to turn off the mute feature.
	If you are using the speakerphone, objects may be obstructing the microphone.	Do not obstruct the unit's microphone during calls. Keep your hands, as well as common objects such as folders, cups, and coffee pots away from the unit during calls.
Sound cuts out; I can hear myself through the speaker.	You are too far away from the microphone.	Try speaking closer to the microphone.
	The environment is not suited to speakerphone calls.	<ul style="list-style-type: none"> ● Do not use the unit within 2 m (6 ft 7 in) of projectors, air conditioning devices, fans, or other audible or electrical noise emitting devices. ● If using the unit in a room with windows, close the curtains or blinds to prevent echoes. ● Use the unit in a quiet environment.
	The unit was moved during a call.	Do not move the unit while on a call.
	Objects are obstructing the microphone.	Do not obstruct the unit during calls. Keep your hands, as well as common objects such as folders, cups, and coffee pots away from the unit during calls.

Appendix

Issue	Possible Cause	Solution
	The other party is using a half-duplex speakerphone.	If the other party is using a half-duplex speakerphone, sound may cut out occasionally during calls. For best performance, the other party should use a full-duplex speakerphone.

Phonebook List

Issue	Possible Cause	Solution
I cannot add or edit entries to the phonebook list.	The phonebook list is full.	Delete any unnecessary entries. The maximum number of entries in the phonebook list is 500.

Error Messages

During operation, error messages might appear on the unit. The following table lists these messages and possible causes and solutions.

Error Message	Possible Cause	Solution
Error:001 Check LAN cable.	The LAN cable is not connected.	Check all connections.
Error:002 IP Address Collision	The unit's network settings are incorrect.	Consult your system administrator or dealer.
Error:002 IP Address		
Error:003 Not Registered	Failed to register to SIP server.	Consult your system administrator or dealer.
Memory Full	The Phonebook is full and cannot store the new item.	Remove unnecessary data in the Phonebook and try again.
No Entries	When trying to view the Phonebook: No items have been stored. See "Storing an Item in the Local Phonebook", Page 37. When trying to view the Incoming or Outgoing Call Log: No logs have been stored.	
Need Repair	Device fault.	Contact your phone system dealer/ service provider.
Phonebook Error	The memory became full during a phonebook download.	<ul style="list-style-type: none"> ● Remove unnecessary data in the phonebook, or consult your administrator regarding the number of items being downloaded. ● This message disappears if you access the phonebook.

Revision History

Software File Version 02.015

Changed Contents

- Main Menu (Page 22)
 - Changing the Program Keys (Page 45)
 - Key Option—Program Key (Page 59)
 - Display Option—Standby Display (Page 61)
 - Status—Line Status (Page 64)
-

Software File Version 02.040

New Contents

- System Settings—Restart (Page 66)

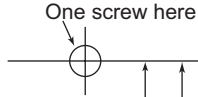

WALL MOUNTING TEMPLATE

1. Drive the screws into the wall as indicated.
2. Hook the unit onto the screw heads.

Note:

Make sure to set the print size to correspond with the size of this page. If the dimensions of the paper output still deviate slightly from the measurements indicated here, use the measurements indicated here.

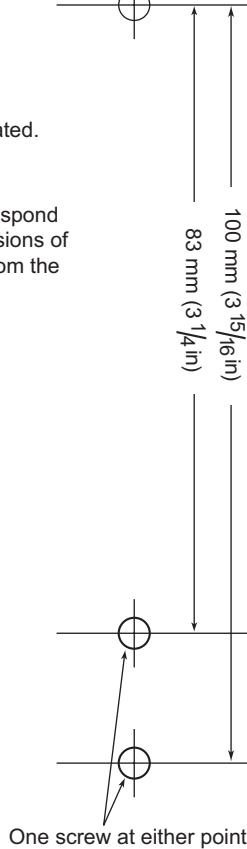

Panasonic System Networks Co., Ltd.

1-62, 4-chome, Minoshima, Hakata-ku, Fukuoka 812-8531, Japan

Web Site: <http://www.panasonic.net/pcc/support/sipphone/>

Panasonic Corporation of North America

Two Riverfront Plaza, Newark, NJ 07102-5490

Web Site: <http://www.panasonic.net/pcc/support/sipphone/>

Panasonic Canada Inc.

5770 Ambler Drive, Mississauga, Ontario, L4W 2T3

Web Site: <http://www.panasonic.com/ca/>

Copyright:

This material is copyrighted by Panasonic System Networks Co., Ltd., and may be reproduced for internal use only. All other reproduction, in whole or in part, is prohibited without the written consent of Panasonic System Networks Co., Ltd.